

# DOWNTOWN BOISE STREETSCAPE STANDARDS & SPECIFICATIONS MANUAL



2'-6" MIN  
2 X BALL DIA.

CONCRETE  
ROOTBALL. TWINE & BURLAP  
REMOVED. THE ROOT FLAR  
MUST BE EXPOSED & PLANTED  
AT GROUND LEVEL.  
BACKFILL W/ TOPSOIL MIX  
6" COMPACTED  
ALL FOOTINGS AND CONCRETE SURROUNDS  
ARE REQUIRED TO BE CONCEALED WITH A  
MOUND OR UNDISTURBED.  
USE 3 FERTILIZER TABLETS

## What is the streetscape?

The streetscape is the part of the street right-of-way between the face of the curb and the building. In downtown Boise, the streetscape includes the sidewalk surface, street trees, historic streetlights, and a collection of furnishings. These furnishings include, but are not limited to, benches, planters for flowers, tree grates, trash receptacles, bicycle racks, transit shelters, newsstands, bollards, and drinking fountains. In areas that have an urban character such as the Central Business District, the sidewalk surface runs from the building face to the curb and street trees are planted in tree grates. In areas that have a neighborhood character, the sidewalk surface is separated from the street by a landscape strip where the street trees are planted. In many areas, green infrastructure such as suspended paving systems and bio-swales are incorporated into the streetscape design, as well.

## Why does the City of Boise have streetscape standards?

Since the mid 1980s, significant investment has been made in downtown Boise's streetscapes. These highly visible improvements have been instrumental to the success of the downtown area. The streetscapes provide a setting for community events, for development of adjoining private property, and for the everyday interaction of people who frequent downtown. Streetscape standards have been established to assure over time that the way downtown sidewalks are designed and the materials and furnishings used on these sidewalks, create a distinct identity and attractive ambiance for downtown. The standards classify streets by the character of the area in which they are located. For each category, they identify how the sidewalk is surfaced—whether brick, concrete or a combination are used—and the specific make, model, and color of the furnishings that are to be installed. The streetscapes create a common design thread throughout the downtown area which contributes to a feeling of coherence and continuity.



The Downtown Boise Streetscape Standards and Specifications Manual is a user friendly-guide to help identify and specify streetscape design in the four downtown urban renewal districts. By following the four-step design process, users will be able to correctly develop their streetscape installation to meet Boise City streetscape requirements.

Boise City sets streetscape standards by council adoption and incorporation into planning and zoning documents. Boise City Design Review ensures streetscape standards are as part of development applications, and considers any modification and/or waiver thereof. Boise City staff inspects and enforces streetscape standards through the building division of Planning & Development Services (PDS). Additionally, the Ada County Highway District (ACHD) has approval authority for improvements in the public rights-of-way.

Capital City Development Corporation (CCDC) does not set, inspect, or enforce streetscape standards for downtown Boise. CCDC does offer participation assistance for public improvements on a case-by-case basis in accordance with the CCDC Participation Program. Those seeking assistance for streetscape improvements should contact CCDC as early in the design process as possible to ensure proposed improvements are eligible and that funds are available.



Find the Streetscape Type for Your Parcel

PAGE 1



Find the Standards for Your Streetscape Type

PAGE 3-17



Find the Specifications for Your Streetscape Type

PAGE 19-55



Find the Quality Control Standards and Conditions for Your Streetscape Project

PAGE 57-61

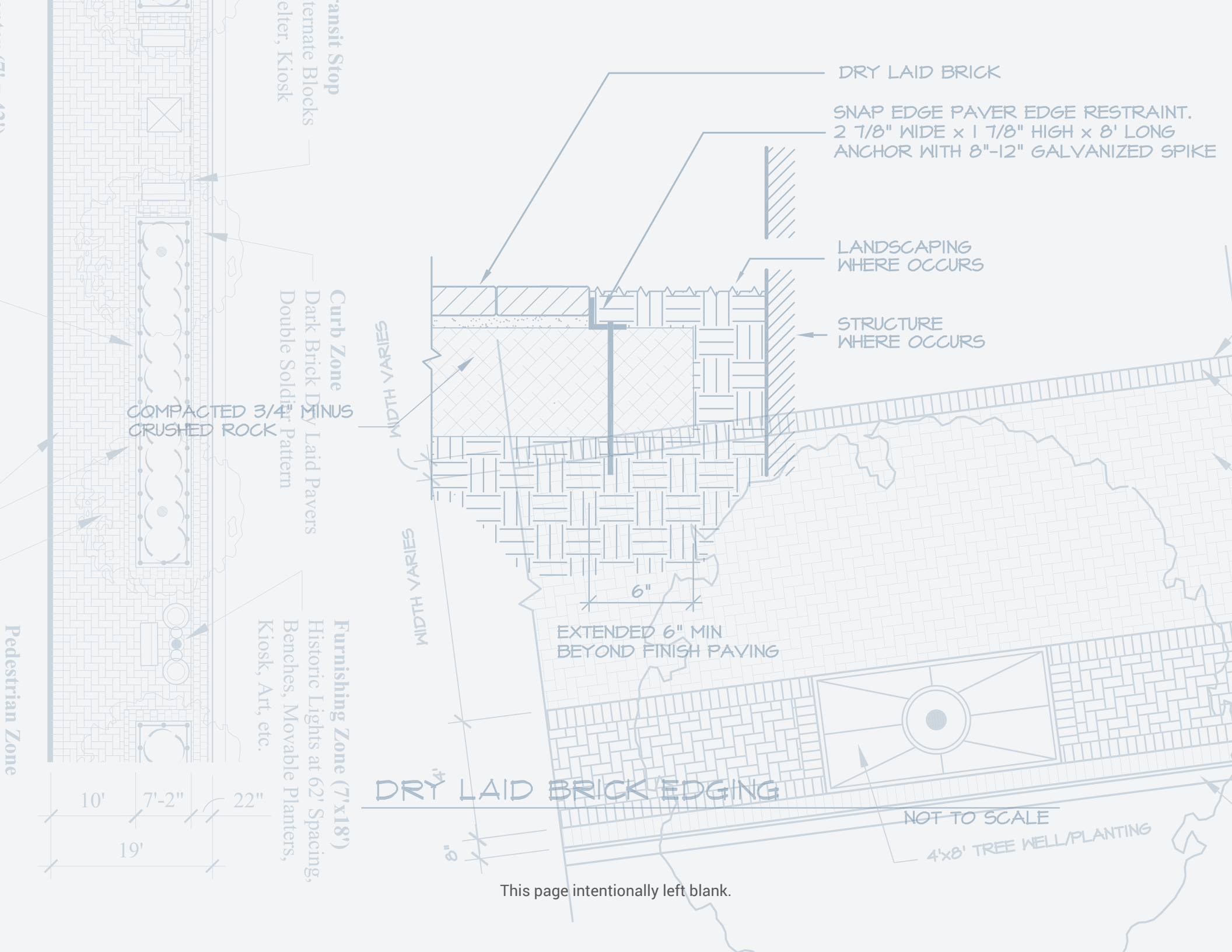

**Transit Stop**

Alternate Blocks  
 elter, Kiosk

**Curb Zone**

Dark Brick Dry Laid Pavers  
 Double Solid Pattern

**Furnishing Zone (7'x18')**

Historic Lights at 62' Spacing,  
 Benches, Movable Planters,  
 Kiosk, Art, etc.

**Pedestrian Zone**

DRY LAID BRICK

SNAP EDGE PAVER EDGE RESTRAINT.  
 2 7/8" WIDE x 1 7/8" HIGH x 8' LONG  
 ANCHOR WITH 8"-12" GALVANIZED SPIKE

LANDSCAPING  
 WHERE OCCURS

STRUCTURE  
 WHERE OCCURS

COMPACTED 3/4" MINUS  
 CRUSHED ROCK

WIDTH VARIES

WIDTH VARIES

EXTENDED 6" MIN  
 BEYOND FINISH PAVING

DRY LAID BRICK EDGING

NOT TO SCALE

4'x8' TREE WELL/PLANTING

10' 7'-2" 22"  
 19'

This page intentionally left blank.



# Find the Streetscape Type for Your Parcel

## STREETSCAPE MAP TYPES

- 1  URBAN BRICK
- 2  URBAN CONCRETE W/ BRICK
- 3  URBAN CONCRETE
- 4  NEIGHBORHOOD
- 5  URBAN PARKWAY
- 6  CAPITOL BOULEVARD
- 7  FAIRVIEW-MAIN GREEN STREET
- SPECIAL
- PROPOSED STREET CONNECTIONS



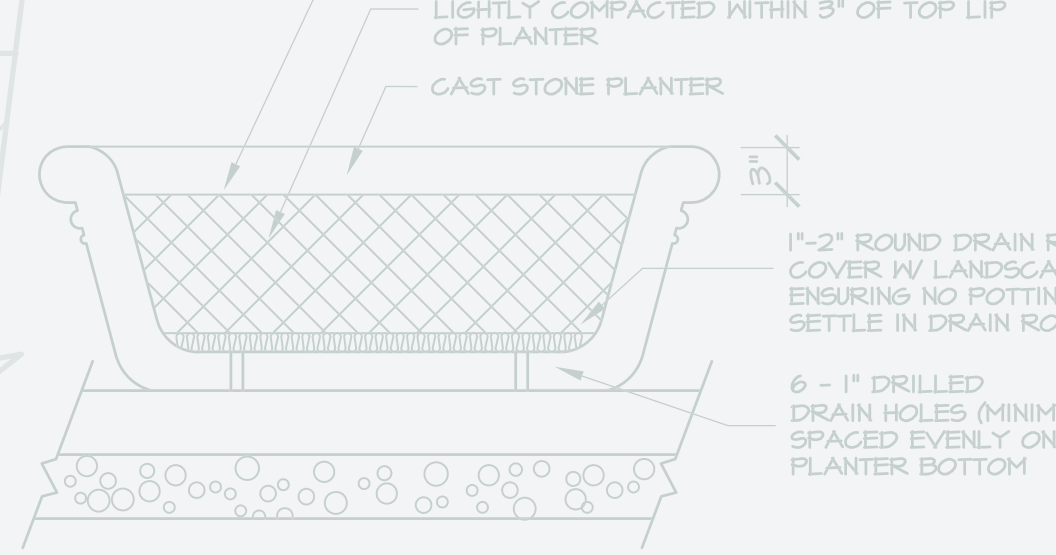

CCDC STANDARD 3-FOOT ROUND x 17-INCH HEIGHT CAST STONE PLANTER. BY IDAHO PRECAST CONCRETE, NAMPA, ID (208) 461-6300. OR EQUIVALENT AS APPROVED BY CCDC.

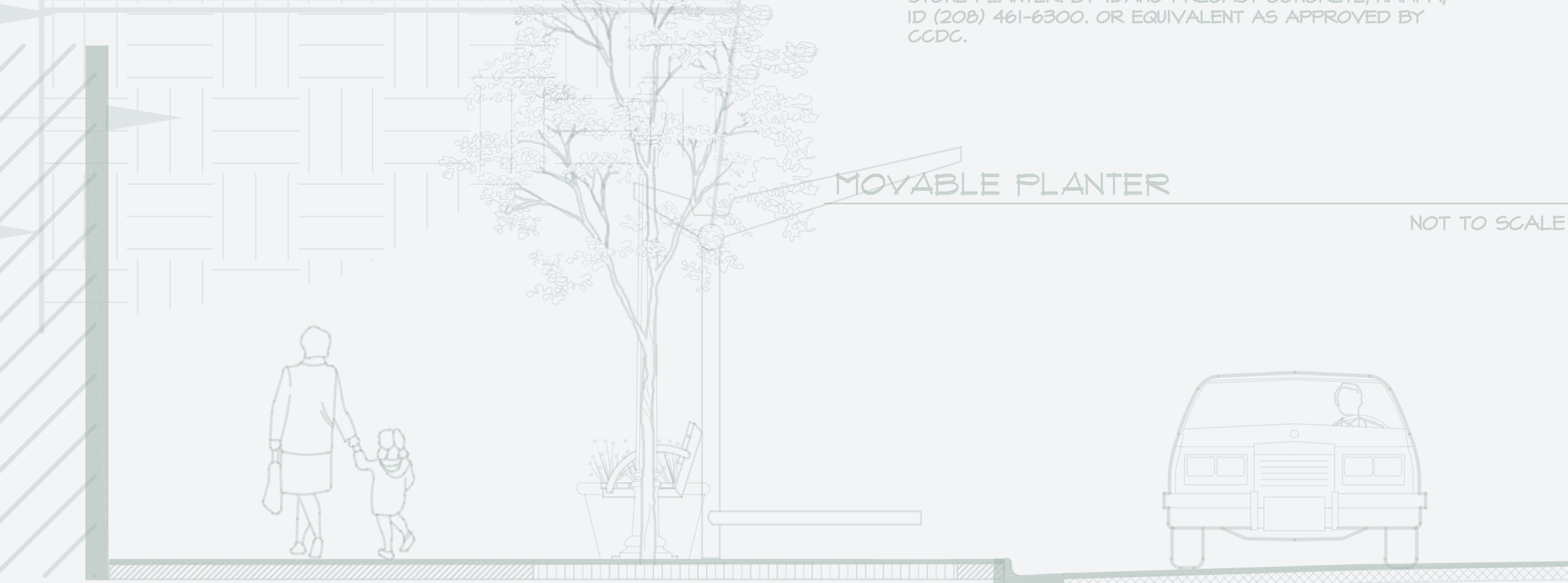

NOT TO SCALE

Varies

This page intentionally left blank.

8"

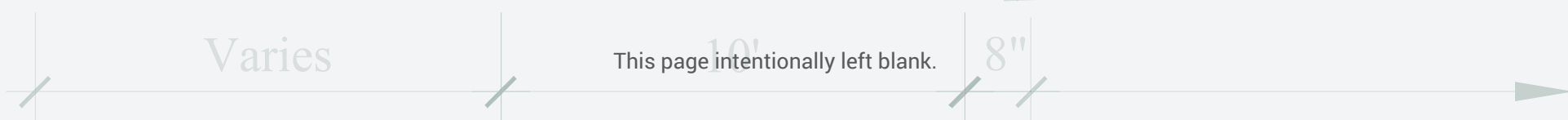



# 2

## Find the Standards for Your Streetscape Type

Type 1	»	Urban Brick	4-5
Type 2	»	Urban Concrete w/ Brick	6-7
Type 3	»	Urban Concrete	8-9
Type 4	»	Neighborhood	10-11
Type 5	»	Urban Parkway	12-13
Type 6	»	Capitol Boulevard	14-15
Type 7	»	Fairview-Main Green Streets	16-17



# Type 1 :: Urban Brick

Urban Brick Streetscape is generally located in business and mixed-use districts where there is a concentration of higher intensity development, ground floor retail, restaurants and entertainment uses, and on-street parking. It also may also be used with offices and housing at street level when such uses are located in business or mixed-use districts rather than neighborhoods.

Urban Brick Streetscape is used to designate certain streets as focused on pedestrians and to create a visible network of comfortable people-oriented streets where significant attention is given to the aesthetic quality of the pedestrian environment. Brick is required on designated sidewalks in high activity centers such as the downtown core to create distinctive places for people to gather, live, work, shop, dine and socialize, where extra emphasis is desired to signify the importance of these focal points of people activity.

## LANDSCAPE REQUIREMENTS

- Street Trees 29

Class II trees in furnishing zone and in same alignment as Historic Streetlights. Trees to be spaced approximately 28'-32' apart and installed in tree wells. Tree well root barrier required by ACHD. Coordinate planning and installation of trees with Boise City Community Forestry, (208) 608-7700.

## HARDSCAPE REQUIREMENTS

- Dry Laid Brick Pavers 20-24

Dry laid brick paver surface extends from curb to face of building. Pattern and color of brick varies by building frontage zone, pedestrian zone, furnishing zone, and curb zone.

- » Curb Zone: 1 soldier course (8" wide) of red dry laid brick.
- » Furnishing Zone: 4' wide. Dark brick dry laid pavers with single soldier course each side and ends with herringbone field.
- » Pedestrian Zone: Minimum 8' wide section of red brick dry laid pavers in herringbone pattern.
- » Building Frontage Zone: Minimum 8" wide row of dark brick dry laid pavers in soldier course pattern. Width varies and is determined by the irregularity of the building face.
- » Pedestrian Ramps at crosswalk per ACHD Standards.

- Suspended Paving Systems 26

Suspended Paving Systems (SPS) are required under the hardscape surface. Design to be determined by site specific conditions.

- Tree Grates and Frames 28

- » 4'x 8' cast iron tree grates and frames to be installed.

- Streetlights 32

- » Spacing: Approximately 56' - 64' spacing in same alignment as trees. Lights should be centered between trees and conflicts with trees to be avoided.
- » Installation: Coordinate with Boise City Public Works Department, (208) 384-3900.



## SITUATIONAL FURNISHINGS

Number and location of furnishings will be determined by Boise City through its design review process, and may include:

Bench	36-37
Litter Receptacle	38-39
Bike Rack	40-41
Movable Planters	44-45

Parking meters to be located per Boise City Parking Standards and placed to avoid conflicts with all other streetscape furnishings. Coordinate meter placement and accessible parking spaces with Boise City Parking Control, (208) 384-3700.

### NOTE:

The dimensions of the pedestrian zone and frontage zone will vary with overall sidewalk width.

All furnishings, trees, and improvements in the street right-of-way will require approval by ACHD, (208) 387-6170.

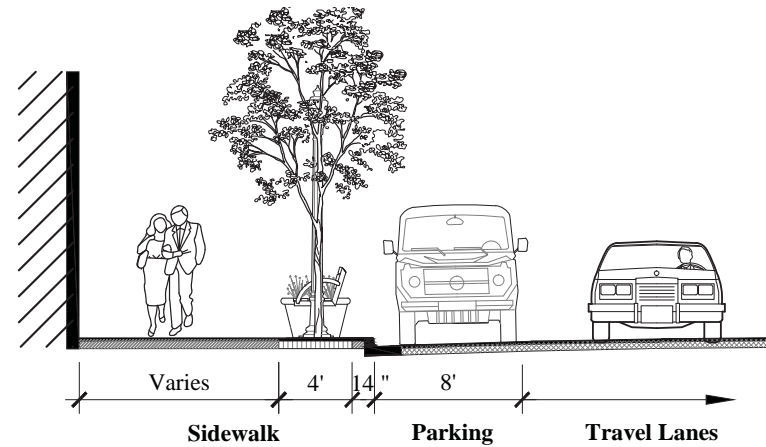

**TYPE 1 - URBAN BRICK STREETSCAPE SECTION**

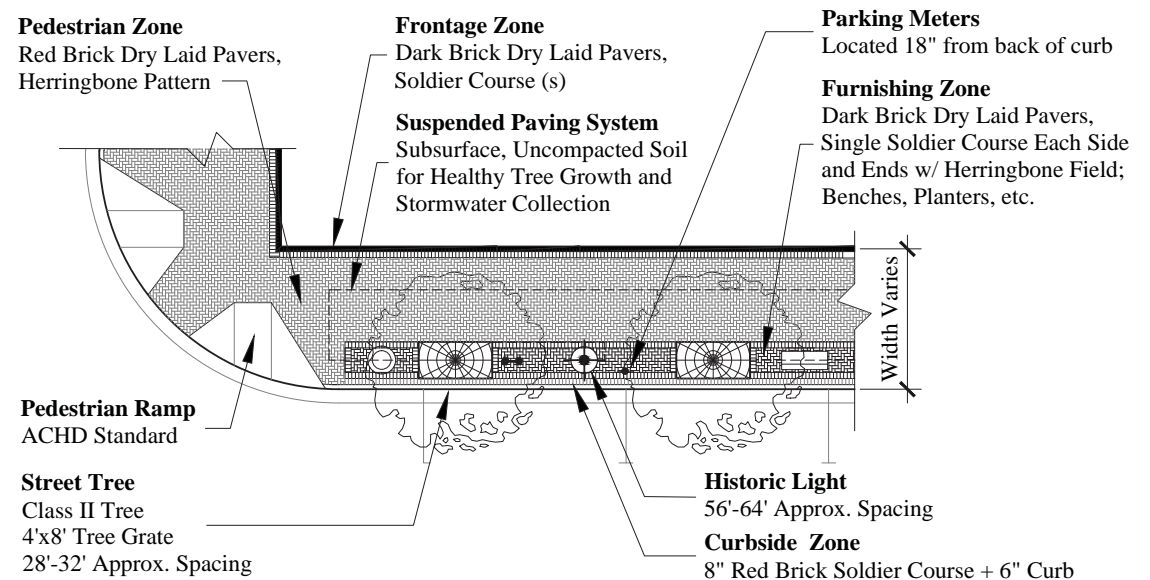

**TYPE 1 - URBAN BRICK STREETSCAPE DETAIL PLAN**

JBA 2015

# Type 2 :: Urban Concrete with Brick

Urban Concrete with Brick Streetscape is generally located in business and mixed-use districts where there is a concentration of higher intensity development, ground floor retail, restaurants and entertainment uses, and on-street parking. It is designed for heavy pedestrian use and to be compatible with retail or similar uses in a dense urban environment.

Urban Concrete with Brick may also be used with offices and housing at street level when such uses are located in business or mixed-use districts rather than in neighborhoods.

## LANDSCAPE REQUIREMENTS

- Street Trees 29

Class II trees in furnishing zone and in same alignment as Historic Streetlights. Trees to be spaced approximately 28'-32' apart and installed in tree wells. Tree well root barrier required by ACHD. Coordinate planning and installation of trees with Boise City Community Forestry, (208) 608-7700.

## HARDSCAPE REQUIREMENTS

- Modular Scored Concrete and Red Dry Laid Brick Pavers 20-23, 25

Modular scored concrete extends from building face to furnishing zone. Red dry laid brick pavers are used in the furnishing zone.

- » Curb zone: 8" concrete curb zone.
- » Furnishing zone: 4' wide. Red brick dry laid pavers; single soldier course on each side and ends with herringbone field.
- » Pedestrian zone: Minimum width of pedestrian zone is 8'. Concrete with trowel joint parallel and cross scores at 4' intervals. No parallel scores are made within 6" of the building foundation.
- » Pedestrian ramps at crosswalk per ACHD Standards.

- Suspended Paving Systems 26

Suspended Paving Systems (SPS) are required under the hardscape surface. Design to be determined by site specific conditions.

- Tree Grates and Frames 28

- » 4'x 8' cast iron tree grates and frames to be installed. Corners of tree grates to align with sidewalk score lines.

- Streetlights 32

- » Spacing: Approximately 56' - 64' spacing in same alignment as trees. Lights should be centered between trees and conflicts with trees to be avoided.
- » Installation: Coordinate with Boise City Public Works Department, (208) 384-3900.

## SITUATIONAL FURNISHINGS

Number and location of furnishings will be determined by Boise City through its design review process, and may include:

Bench	36-37
Litter Receptacle	38-39
Bike Rack	40-41
Movable Planters	44-45

Parking meters to be located per Boise City Parking Standards and placed to avoid conflicts with all other streetscape furnishings. Coordinate meter placement and accessible parking spaces with Boise City Parking Control, (208) 384-3700.

### NOTE:

The dimensions of the pedestrian zone and frontage zone will vary with overall sidewalk width.

All furnishings, trees, and improvements in the street right-of-way will require approval by ACHD, (208) 387-6170.

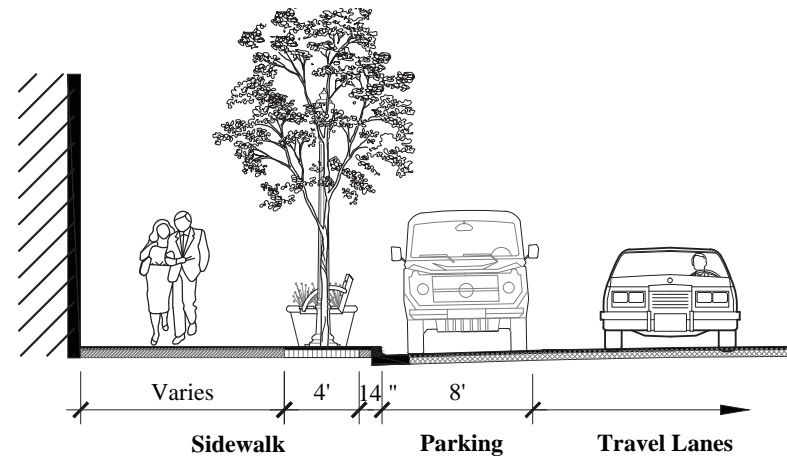

**TYPE 2 - URBAN BRICK/CONCRETE STREETSCAPE SECTION**

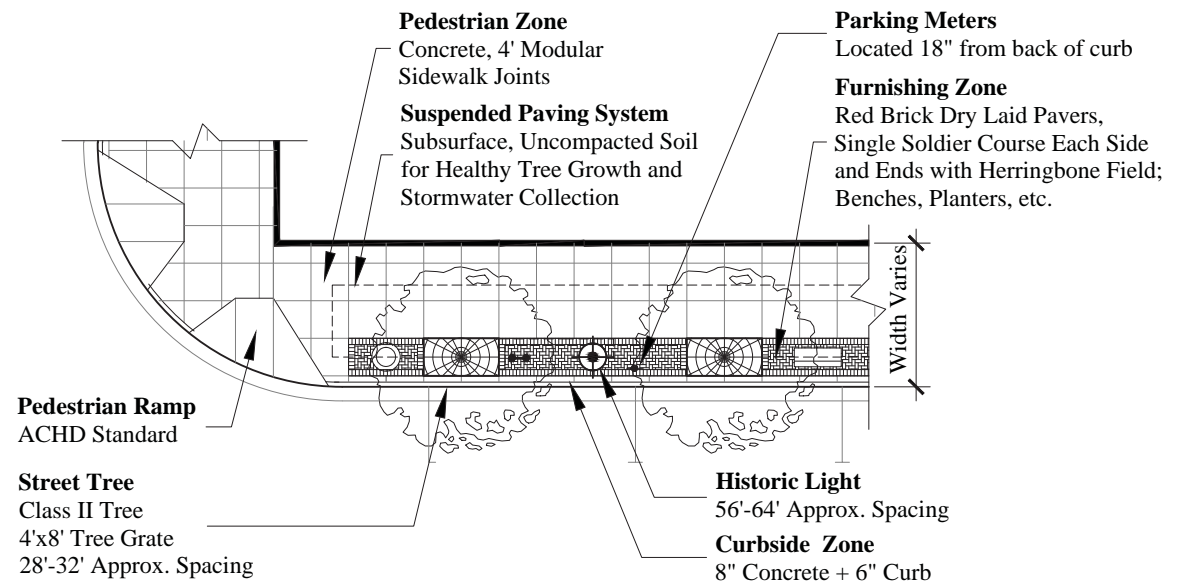

**TYPE 2 - URBAN BRICK/CONCRETE STREETSCAPE DETAIL PLAN**

JBA 2015

# Type 3 :: Urban Concrete

Urban Concrete Streetscape is generally located in business and mixed-use districts where there is a concentration of higher intensity development, ground floor retail, restaurants and entertainment uses, and on-street parking.

Urban Concrete is designed for heavy pedestrian use and to be compatible with retail or similar uses in a dense urban environment. It may also be used with offices and housing at street level when such uses are located in business or mixed-use districts rather than neighborhoods.

## LANDSCAPE REQUIREMENTS

- Street Trees 29

Class II trees in furnishing zone and in same alignment as Historic Streetlights. Trees to be spaced approximately 28'-32' apart and installed in tree wells. Tree well root barrier required by ACHD. Coordinate planning and installation of trees with Boise City Community Forestry, (208) 608-7700.

## HARDSCAPE REQUIREMENTS

- Modular Scored Concrete 23, 25
  - » Curb zone: 8" concrete curb zone.
  - » Furnishing zone: 4' wide. Concrete in furnishing zone is scored in 2' intervals.
  - » Pedestrian zone: Minimum width of pedestrian zone is 8'. Concrete with trowel joint parallel and cross scores at 4' intervals. No parallel scores are made within 6" of the building foundation.
  - » Pedestrian ramps at per ACHD Standards.
- Suspended Paving Systems 26

Suspended Paving Systems (SPS) are required under the hardscape surface. Design to be determined by site specific conditions.
- Tree Grates and Frames 28
  - » 4'x 8' cast iron tree grates and frames to be installed. Corners of tree grates to align with sidewalk score lines.
- Streetlights 32-33
  - » Spacing: Approximately 56' - 64' spacing in same alignment as trees. Lights should be centered between trees and conflicts with trees to be avoided.
  - » Installation: Coordinate with Boise City Public Works Department, (208) 384-3900.

## SITUATIONAL FURNISHINGS

Number and location of furnishings will be determined by Boise City through its design review process, and may include:

Bench	36-37
Litter Receptacle	38-39
Bike Rack	40-41
Movable Planters	44-45

Parking meters to be located per Boise City Parking Standards and placed to avoid conflicts with all other streetscape furnishings. Coordinate meter placement and accessible parking spaces with Boise City Parking Control, (208) 384-3700.

### NOTE:

The dimensions of the pedestrian zone and frontage zone will vary with overall sidewalk width.

All furnishings, trees, and improvements in the street right-of-way will require approval by ACHD, (208) 387-6170.

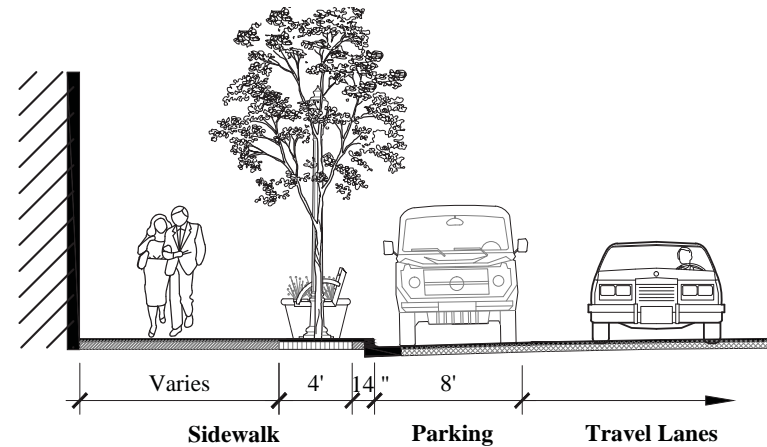

**TYPE 3 - URBAN CONCRETE STREETScape SECTION**

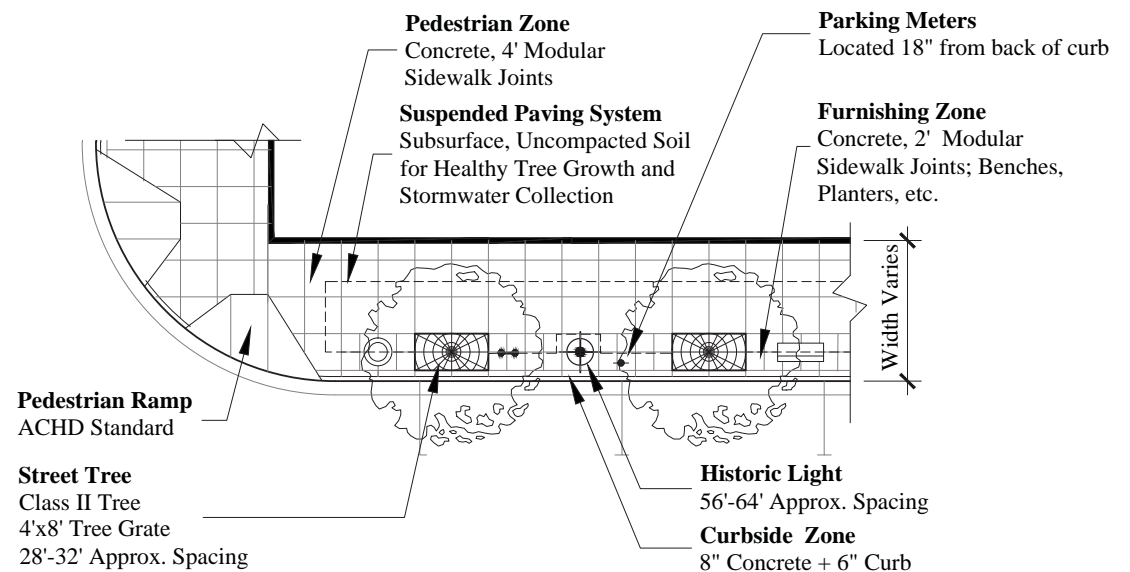

**TYPE 3 - URBAN CONCRETE STREETScape DETAIL PLAN**

JBA 2015

# Type 4 :: Neighborhood

The Neighborhood Streetscape is used in areas of downtown that have less intense development with a higher proportion of residential uses and more limited retail and office uses. It is designed to accommodate pedestrian traffic in locations where a residential neighborhood character is desired.

The distinguishing characteristic of this style of streetscaping is the use of softscape and street trees between the sidewalk and the street, rather than continuing the sidewalk surface to the curb. The intent of the neighborhood streetscape is to create a pleasant pedestrian environment and encourage walking as an alternative to using an automobile. The Neighborhood Streetscape is compatible with housing, office, and limited retail uses.

## LANDSCAPE REQUIREMENTS

54

- Street Trees: Class II trees in lawn strip in same alignment as Historic Streetlights. Where the lawn strip is at least 10' in width, Class III trees may be recommended or required depending on land use and other local conditions. Class II trees to be spaced approximately 30' apart, or 40' apart for Class III trees. Coordinate planning and installation of trees with Boise City Community Forestry, (208) 608-7700.
- Lawn Strip: The width of the lawn strip will vary according to local conditions but is at least 8' to allow for street trees. The lawn strip may be sodded with grass or other more water efficient plantings/xeriscaping.
- Landscape Zone (between building face and sidewalk): Turf or low shrubs are appropriate but design and materials may vary according to setback standards and conditions related to site, building, and use.

## HARDSCAPE REQUIREMENTS

- Concrete 23
  - » Curbside Walk: 18" wide concrete. Optional use to protect lawn.
  - » Pedestrian zone: Minimum width of pedestrian zone is 6'. Concrete with trowel joint parallel and cross scores at 4'-6" intervals.
  - » Pedestrian ramps at crosswalk per ACHD Standards.
- Streetlights 32-33
  - » Spacing: Approximately 60' separation and in same alignment as trees. Lights to be centered between trees and conflicts with trees should be avoided.
  - » Installation: Coordinate with Boise City Public Works Department, (208) 384-3900.

## GREEN STREET OPTION

27

Bioretention planters or bioswales are an acceptable alternative to a conventional tree lawn or landscape strip. Bioretention facilities help to treat stormwater runoff from the street and adjacent areas, reducing pollutant discharge into the Boise River and providing street trees with some of the water they need. Bioretention facilities require different design from conventional tree lawns, including special soils and tree selection. Contact ACHD at (208) 387-6170 for details.

## SITUATIONAL FURNISHINGS

Number and location of furnishings will be determined by Boise City through its design review process, and may include:

Bench	36-37
Litter Receptacle	38-39
Bike Rack	40-41
Movable Planters	44-45

Parking meters to be located per Boise City Parking Standards and placed to avoid conflicts with all other streetscape furnishings. Coordinate meter placement and accessible parking spaces with Boise City Parking Control, (208) 384-3700.

### NOTE:

All furnishings, trees, and improvements in the street right-of-way will require approval by ACHD, (208) 387-6170.

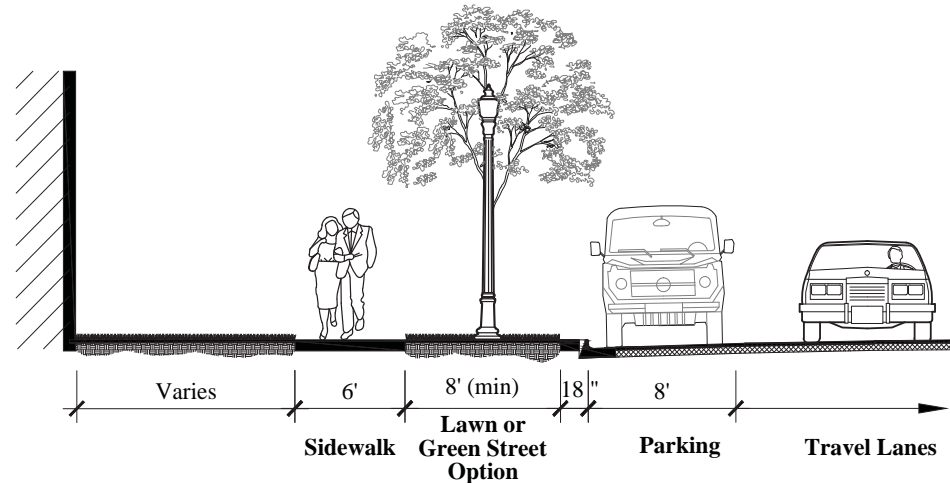

**TYPE 4 - NEIGHBORHOOD STREETSCAPE SECTION**

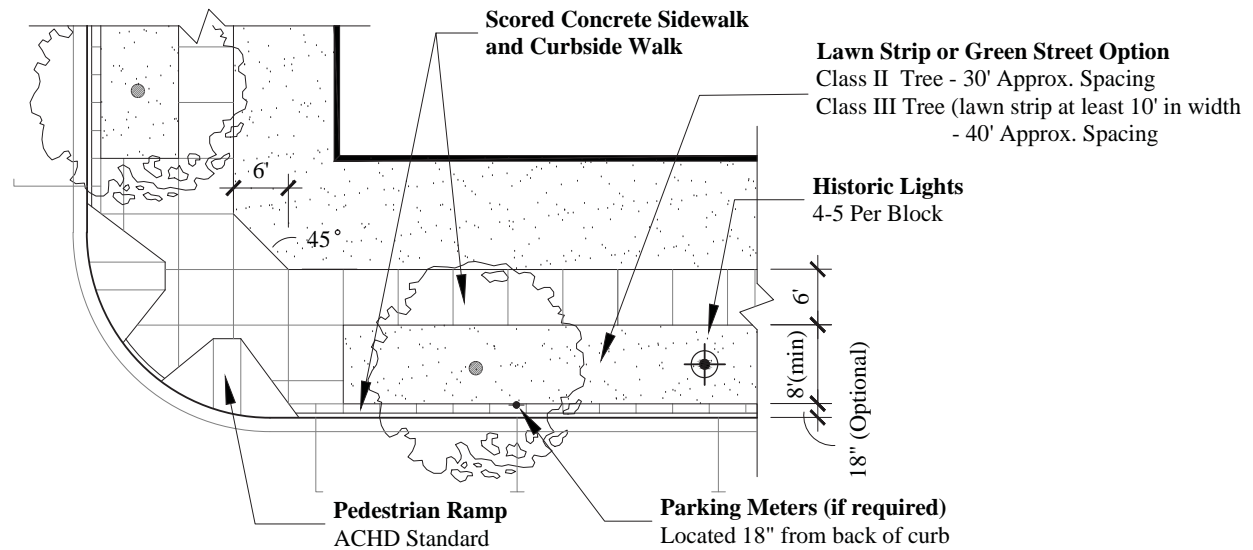

**TYPE 4 - NEIGHBORHOOD STREETSCAPE DETAIL PLAN**

JBA 2015

# Type 5 :: Urban Parkway

The Urban Parkway Streetscape is used on major streets that carry higher volumes of traffic at faster speeds than is typical for the downtown core. The intent of using a parkway treatment is to provide beautification of significant streets such as State Street, Whitewater Park Boulevard, and the Connector and to create a comfortable pedestrian walking environment so that the streets serve pedestrians in addition to vehicles. The standards are established to provide a strong visual statement with a double rather than single row of street trees in tree lawn, adequate room for pedestrian movement, and a buffer between pedestrians and relatively heavy auto and truck traffic.

## LANDSCAPE REQUIREMENTS

54

- **Street Trees:** Where the lawn strip is at least 10' in width, Class III trees may be recommended or required depending on land use and other local conditions. Trees to be spaced approximately 50', staggered rows where applicable. Coordinate planning and installation of trees with Boise City Community Forestry, (208) 608-7700.
- **Landscape Strip:** The width of the landscape strip will vary according to local conditions but is generally 10' minimum. Landscape strip to be planted with lawn or shrub plantings.
- **Landscape Zone (between building face and sidewalk):** Surface width behind sidewalk should be sufficient to accommodate a row of trees. Turf or low shrubs are appropriate but design and materials may vary according to setback standards and conditions related to site, building and use.

## HARDSCAPE REQUIREMENTS

- **Concrete** 23
  - » Pedestrian Zone: Minimum width of Pedestrian Zone is 8' with 4' modular scored concrete.
  - » Pedestrian ramps at crosswalk per ACHD Standards.
- **Streetlights** 32-33
  - » Spacing: Approximately 100' spacing and in same alignment as trees. Lights to be centered between trees and conflicts with trees should be avoided.
  - » Installation: Coordinate with Boise City Public Works Department, (208) 384-3900.

## GREEN STREET OPTION

27

Bioretention planters or bioswales are an acceptable alternative to a conventional tree lawn or landscape strip. Bioretention facilities help to treat stormwater runoff from the street and adjacent areas, reducing pollutant discharge into the Boise River and thereby providing street trees with some of the water they need. Bioretention facilities require different design from conventional tree lawns, including special soils and tree selection. Contact ACHD at (208) 387-6170 for details.



## SITUATIONAL FURNISHINGS

Number and location of furnishings will be determined by Boise City through its design review process, and may include:

Bench	36-37
Litter Receptacle	38-39
Bike Rack	40-41
Movable Planters	44-45

Parking meters to be located per Boise City Parking Standards and placed to avoid conflicts with all other streetscape furnishings. Coordinate meter placement and accessible parking spaces with Boise City Parking Control, (208) 384-3700.

### NOTE:

All furnishings, trees, and improvements in the street right-of-way will require approval by ACHD, (208) 387-6170.

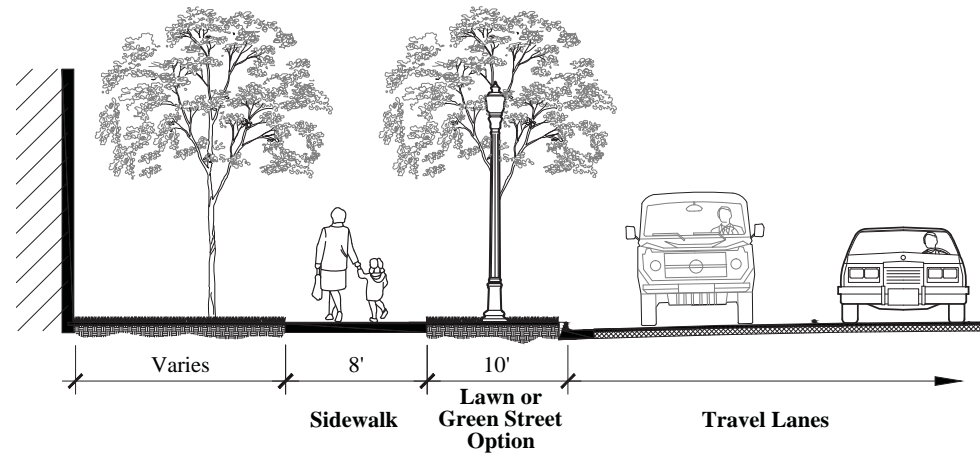

**TYPE 5 - URBAN PARKWAY STREETSCAPE SECTION**

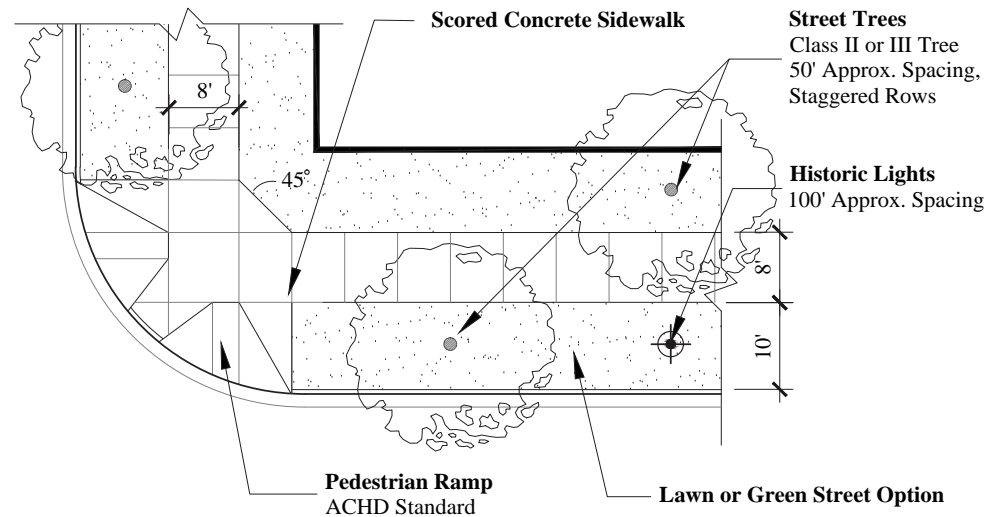

**TYPE 5 - URBAN PARKWAY STREETSCAPE DETAIL PLAN**

JBA 2015

# Type 6 :: Capitol Boulevard

Capitol Boulevard is one of the principal gateway streets in Boise. It links two of the most important historic buildings in the city - the State Capitol and the Boise Depot. In between these buildings lie a variety of uses that are of importance to the community, including cultural centers and parks, Boise State University, hotels, retail establishments, and restaurants. At Fulton Street, the uses along Capitol Boulevard make a distinct transition from university campus, regional parks, and institutional uses to the downtown core. This change in streetscape from urban parkway to urban hardscape with planters reflects that transition. Please refer to the Capitol Boulevard Streetscape Master Plan owned by Boise City PDS for additional details.

## LANDSCAPE REQUIREMENTS

- Street Trees 29  
Class II trees in planters in same alignment as Historic Streetlights. Trees to be spaced approximately 30' apart and installed two per planter, approximately 6' from either end. Coordinate planning and installation of trees with Boise City Community Forestry, (208) 608-7700.
- Planters  
7'2" wide by 42" long planters, planted with trees and shrubs in accordance with the Capitol Boulevard Streetscape Master Plan.

## HARDSCAPE REQUIREMENTS

- Dry Laid Brick Pavers 20-24  
Dry laid brick paver surface extends from curb to face of building. Pattern and color of brick varies by building frontage zone, pedestrian zone, furnishing zone, and curb zone.
  - » Curb Zone: Double soldier pattern (16" wide) of dark brick behind 6" wide concrete curb.
  - » Planter Zone: Double soldier pattern (16" wide) of dark brick on all sides of planter frame; inclusive of Curb Zone.
  - » Furnishing Zone: Red dry laid pavers in a herringbone pattern continued from pedestrian zone between planters and planter zone pavers.
  - » Pedestrian Zone: Approximately 7'4" wide section of red brick dry laid pavers in herringbone pattern.
  - » Building Frontage Zone: Double soldier pattern (16" wide) dark brick dry laid pavers.
  - » Pedestrian Ramps at crosswalk per ACHD Standards.
- Steel Railing 15  
Steel railing around all planters per detail drawing. Powdercoat RAL 6009 dark green.
- Streetlights 32
  - » Spacing: Approximately 60' spacing in same alignment as trees and generally centered between planters.
  - » Installation: Coordinate with Boise City Public Works Department, (208) 384-3900.

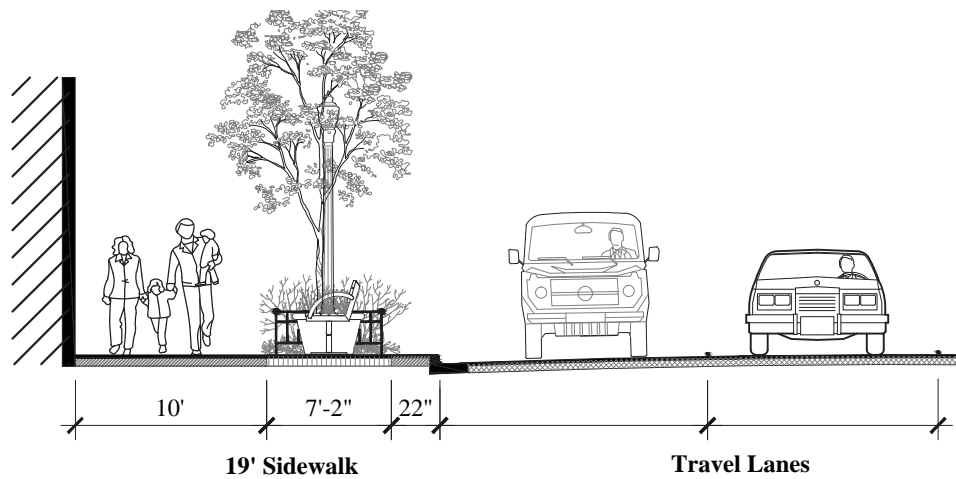

**TYPE 6 - CAPITOL BOULEVARD SECTION**

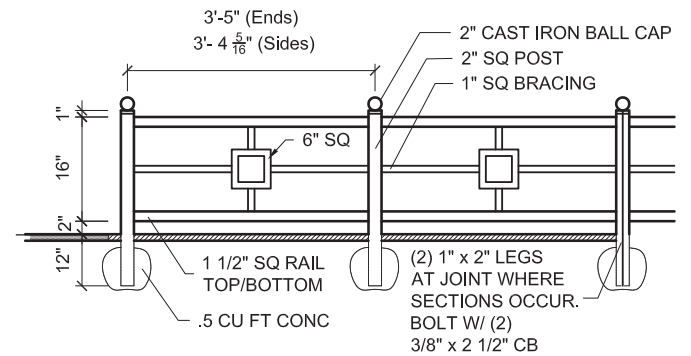

**CAPITOL BLVD PLANTER - SIDE ELEVATION**

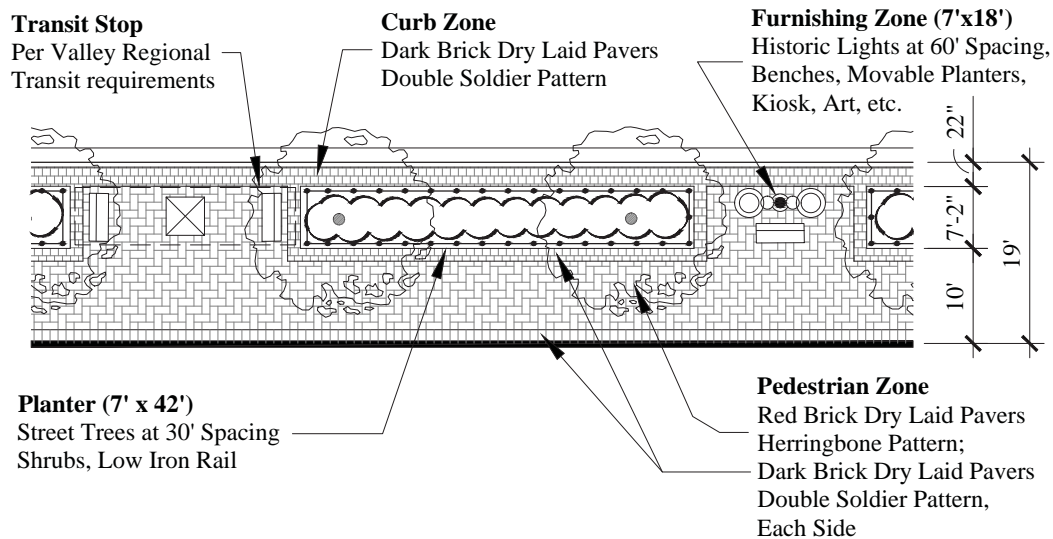

**TYPE 6 - CAPITOL BOULEVARD DETAIL PLAN**

JBA 2015

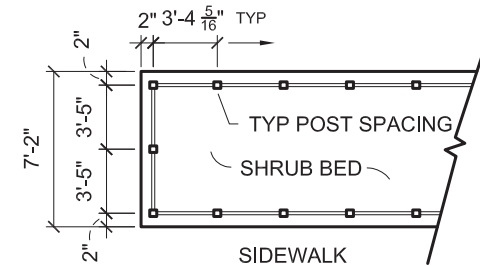

**CAPITOL BLVD PLANTER - PLAN VIEW**

# Type 7 :: Fairview-Main Green Street

Fairview and Main Street will be a showcase for Green Stormwater Infrastructures (GSI) integration into Boise's streetscape environments. Through the use of bioretention planters, stormwater and street runoff will be captured within the streetscape right-of-way, treated and released into the groundwater. Refer to ACHD's Policy Manual Section 8200 - ACHD Stormwater Design Tools and Approved BMPs for stormwater design specifics.

## LANDSCAPE REQUIREMENTS

- Street Trees 29

Class II trees in bioretention planters to be appropriate for bioretention planter conditions. Trees to be centered within bioretention planter area. Trees to be spaced approximately 52' apart. Coordinate planning and installation of trees with Boise City Community Forestry, (208) 608-7700.

- Bioretention Planter 27

Per ACHD Policy Manual Section 8200 - ACHD Stormwater Design Tools and Approved BMPs. Bioretention planters to be planted with material appropriate for bioretention planter conditions.

## HARDSCAPE REQUIREMENTS

- Concrete 23
  - » Pedestrian Zone: Minimum width of Pedestrian Zone is 8' with 4' modular scored concrete.
  - » Pedestrian ramps at crosswalk per ACHD Standards.
- Streetlights 32-33
  - » Spacing: 4 per block and in same alignment as trees. Lights to be centered between trees adjacent to bioretention planter pedestrian crossing.
  - » Installation: Coordinate with Boise City Public Works Department, (208) 384-3900.

## SITUATIONAL FURNISHINGS

Number and location of furnishings will be determined by Boise City through its design review process, and may include:

Bench	36-37
Litter Receptacle	38-39
Bike Rack	40-41
Movable Planters	44-45

Parking meters to be located per Boise City Parking Standards and placed to avoid conflicts with all other streetscape furnishings. Coordinate meter placement and accessible parking spaces with Boise City Parking Control, (208) 384-3700.

### NOTE:

All furnishings, trees, and improvements in the street right-of-way will require approval by ACHD, (208) 387-6170.

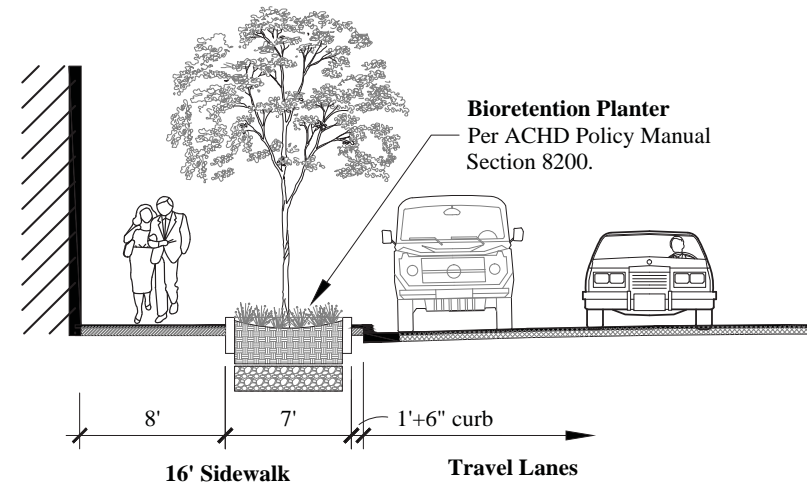

**TYPE 7 - FAIRVIEW & MAIN GREEN STREETS STREETScape SECTION**

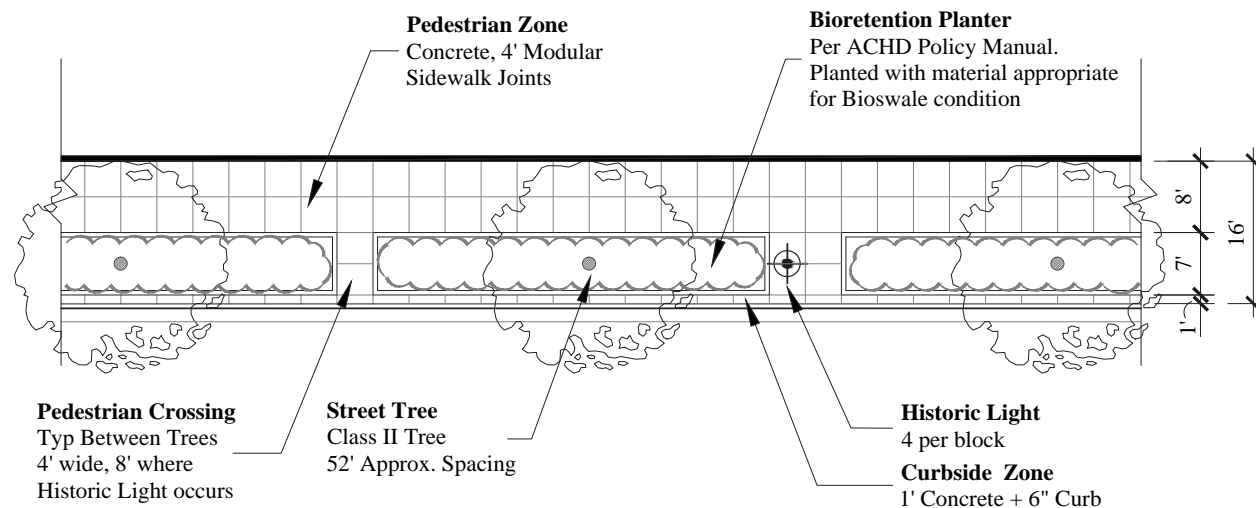

**TYPE 7 - FAIRVIEW & MAIN GREEN STREETS DETAIL PLAN**

JBA 2015

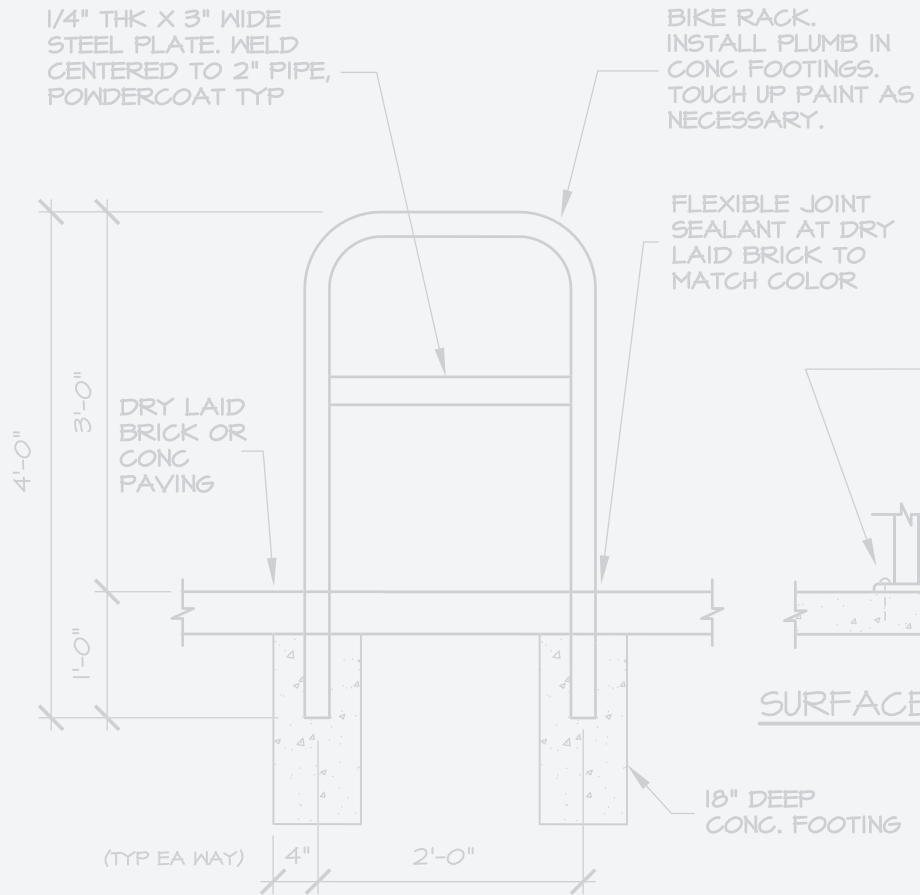

DIRECT BURY

**NOTE:**  
BIKE RACK TO BE 2" ROUND SCH 40 STEEL PIPE;  
BEND TO FORM & DIMENSIONS AS SHOWN.  
POWDERCOAT RAL-6009.

BIKE RACK.  
INSTALL PLUMB IN  
CONC FOOTINGS.  
TOUCH UP PAINT AS  
NECESSARY.

FLEXIBLE JOINT  
SEALANT AT DRY  
LAID BRICK TO  
MATCH COLOR

1/4" x 6" ROUND STEEL  
PLATE. EASE EDGE. WELD  
TO EA POST (2). SECURE  
PLATE W (3) 1/4" x 4"  
VANDALPROOF/  
REMOVABLE EXP BOLTS.  
PREP & PAINT PLATE &  
BOLTS RAL 6009.

SURFACE MOUNT

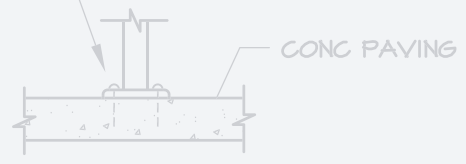

REMOVABLE CAP  
& LOCK PER MFG.

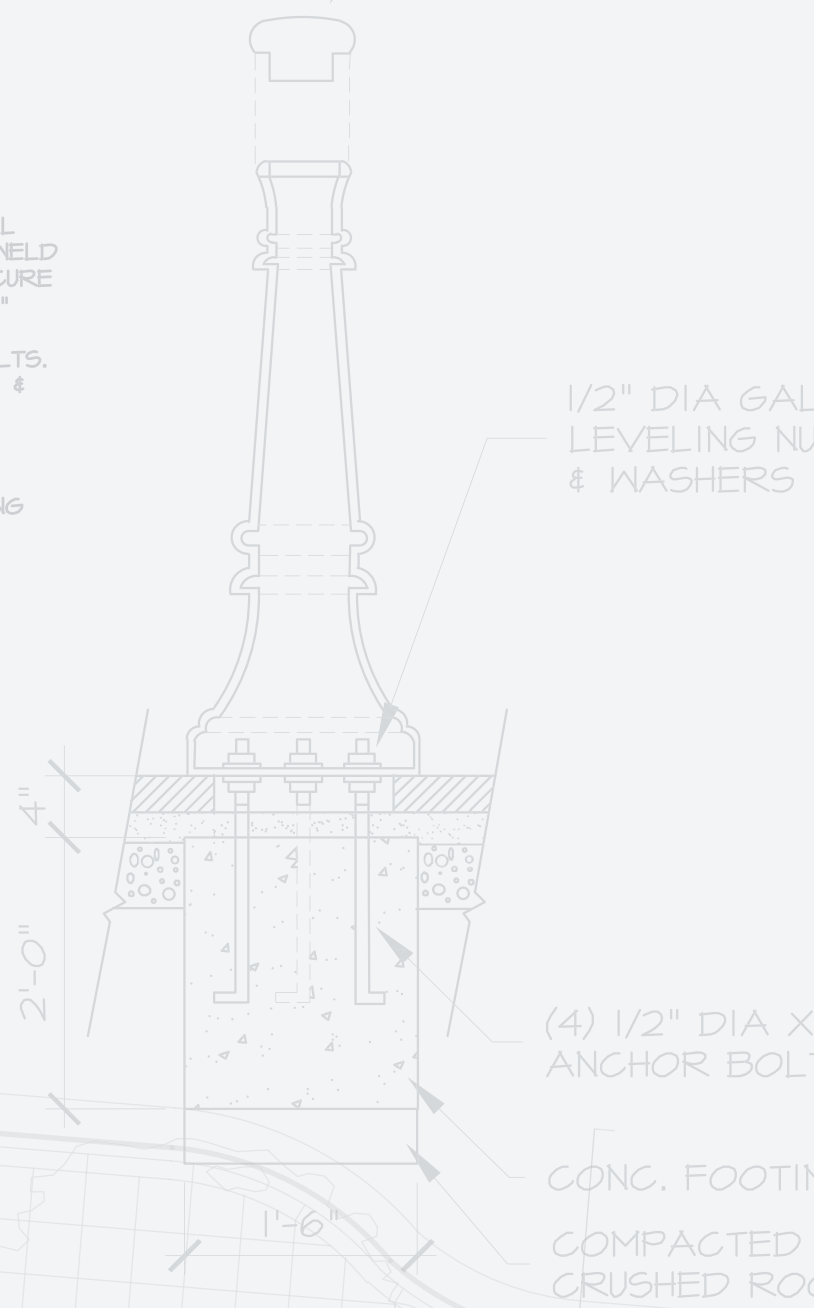

1/2" DIA GAL  
LEVELING NUTS  
& WASHERS

(4) 1/2" DIA X  
ANCHOR BOLT

CONC. FOOTING  
COMPACTED  
CRUSHED ROCK

BIKE RACK

NOT TO SCALE

This page intentionally left blank.

BOLLARD: 1890 SERIES CAST IRON FIXED AND  
REMOVABLE BOLLARD BY CANTURBURY INTER



# 3

## Find the Specifications for Your Streetscape Type

### STREETSCAPE SPECIFICATIONS:

Brick and Concrete Paving	20-23
Paving Patterns	24-25
Suspended Paving System	26
Bioretention Planter & Bioswale	27
Tree Grate & Frame	28
Tree Well & Tree Planting	29
Trench Drain & Grate	30-31
Streetlight	32-33

### SITUATIONAL FURNISHINGS SPECIFICATIONS:

Public Art	34-35
Bench	36-37
Litter Receptacle	38-39

### SITUATIONAL FURNISHINGS CONT...

Bike Rack	40-41
Bike Corral	42-43
Movable Planter	44-45
Tree Guard	46
Table	47
Bollard	48-49
Transit Shelter	50-51
Drinking Fountain	52-53

### LANDSCAPE SPECIFICATIONS:

Landscape Installation	54
Tree Planting in Parkstrip	55

Pavers are used in a variety of ways to define various functional areas of the sidewalk. These areas usually include a building zone along the base of building (dark); a pedestrian zone (red); the furnishing zone for such items as street trees and tree grates, benches and historic lighting (dark); and the curb zone along the street edge (red). Refer to paving pattern details for specific brick layout design.

Permeable paver furnishing zone is optional, subject to approval by ACHD, and may require a geotechnical investigation.

### *Basis for Design:*

#### **BRICK PAVER ORDER INFORMATION:**

2-1/4" thick x 4"x 8" wirecut brick paver with spacing lug. Local representative: The Masonry Center, (208) 375-1362.

Red pavers to be No. 46 Medium Ironspot Blend.

Dark pavers to be Manganese Ironspot.

Equivalent may be substituted as approved by Boise City.



No. 46 Medium  
Ironspot Blend



Manganese Ironspot





## DESCRIPTION

The work consists of furnishing and installing dry laid pavers including crushed rock base, bedding material, and joint filler. If settlement greater than 1/2" occurs within one year after installation, the brick must be adjusted to finish grade plus 1/4".

## MATERIAL

- **Base Course:** Aggregate for crushed rock base shall be 3/4-minus in accordance with Idaho Standards for Public Works Construction (ISPWC), latest edition.
- **Bedding Material:** Material used as bedding layer for the paver shall be well-graded, non-plastic sand, ASTM C33 or 5/16" clean crushed chip gravel.
- **Joint Filler:** Material used for joint filler shall be well graded, non-plastic sand, ASTM C33, or fine #70 silica sand joint filler.
- **Brick Paver:** Pavers shall be 2-1/4" thick x 4" x 8" wirecut brick paver with spacing lug size by Endicott Clay Products Company, Fairbury, Nebraska, or equal. Red Brick Pavers shall be No. 46 Medium Ironspot Blend. Dark Brick Pavers shall be Manganese Ironspot.

## INSTALLATION

### Crushed Rock Base:

Place base course material in 6 inch lifts to a depth whereby the finished surface will conform to the design grades and dimensions with proper allowance for the paving. Compact to 95 percent of the maximum relative density. The final result shall be an unyielding course, free from irregularities, with a smooth, tight, even surface, true to gradient. Maintain the surface of the base course until it is paved or until final acceptance. If ruts, soft spots or other damage occur before such time, the surface should be repaired. Excess moisture or frost in the sub-base, or base course, will be cause for suspending work until normally dry working conditions are restored, and compaction achieved.

### Bedding Material:

Spread a 1" layer of bedding material evenly over the area to be paved and thoroughly water-settle it into the base course. Add material where necessary and achieve 95 percent compaction, to specified lines and grades, less the paver thickness, plus 1/4". Apply a thin layer of bedding material evenly over the area to be paved in preparation for placing the brick. Level bedding material with a screed to specified lines and grades. Under no circumstances should final material bedding be compacted or walked upon after screeding.

### Laying Pavers:

Verify paving pattern prior to proceeding. Lay pavers from inside curb face, parallel, toward building face. Make final brick cuts at building face. Maintain continuous protection of surface from pedestrian traffic until joint filler application in complete. Fill edge gaps with standard edge pieces or with pavers cut to fit. The pavers shall be cut to a straight even surface without cracks or chips. Joints or gaps shall not exceed 1/8". Evenly brush joint filler over entire surface. Mechanically vibrate the surface with a plate vibrator. Use plywood sheeting to protect brick. After vibration the brick surface shall be true to grade, plus 1/4", and shall not vary by more than 1/8" when tested with a 3' straight edge at any location on the surface. Brush joint filler over surface once again, and then brush away and remove excess sand until site is left clean.

Optional permeable paver installation in furnishing zone to be determined on a specific site basis; subject to approval by ACHD and may require a geotechnical investigation. Permeable Pavers to be installed per Interlocking Concrete Pavement Institute (ICPI) Tech Spec 18 - Construction of Permeable Interlocking Concrete Pavement Systems Specifications and Standards

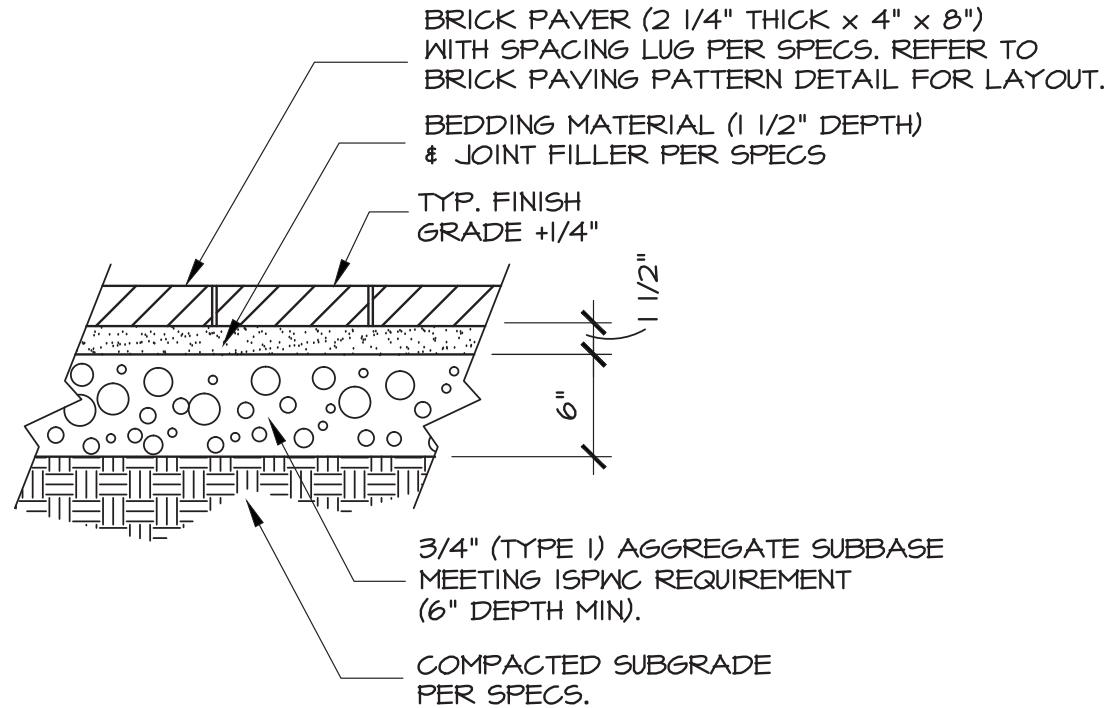

BRICK AT TRAFFIC RATED SIDEWALK SECTIONS TO  
BE MORTARED IN PLACE ON 6" CONCRETE SLAB

## SIDEWALK DRY LAID BRICK PAVING

NOT TO SCALE

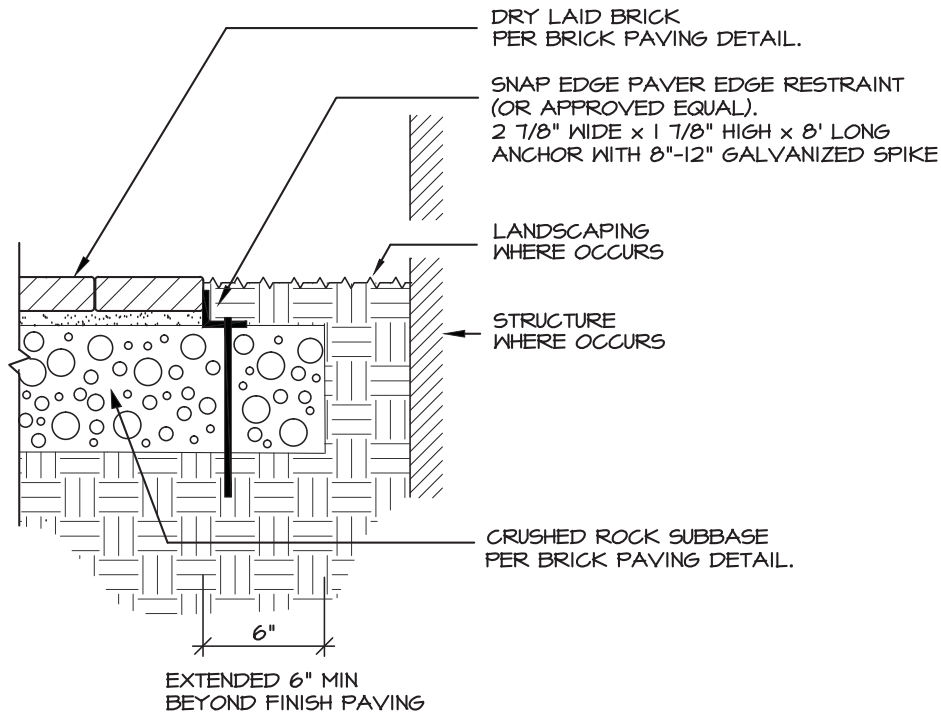

**DRY LAID BRICK EDGING**

NOT TO SCALE

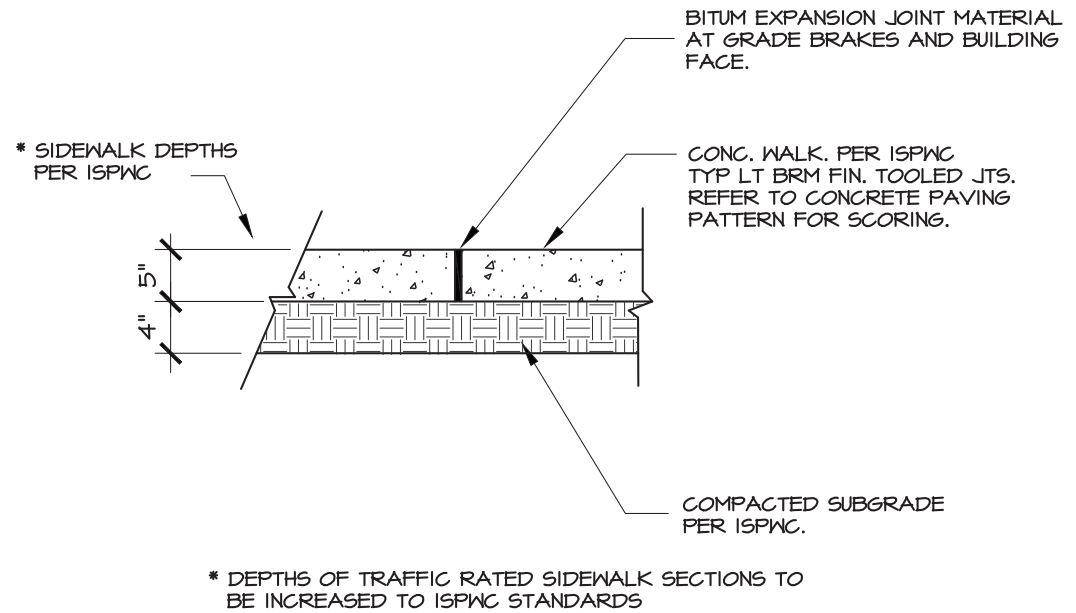

**SIDEWALK CONCRETE PAVING**

NOT TO SCALE

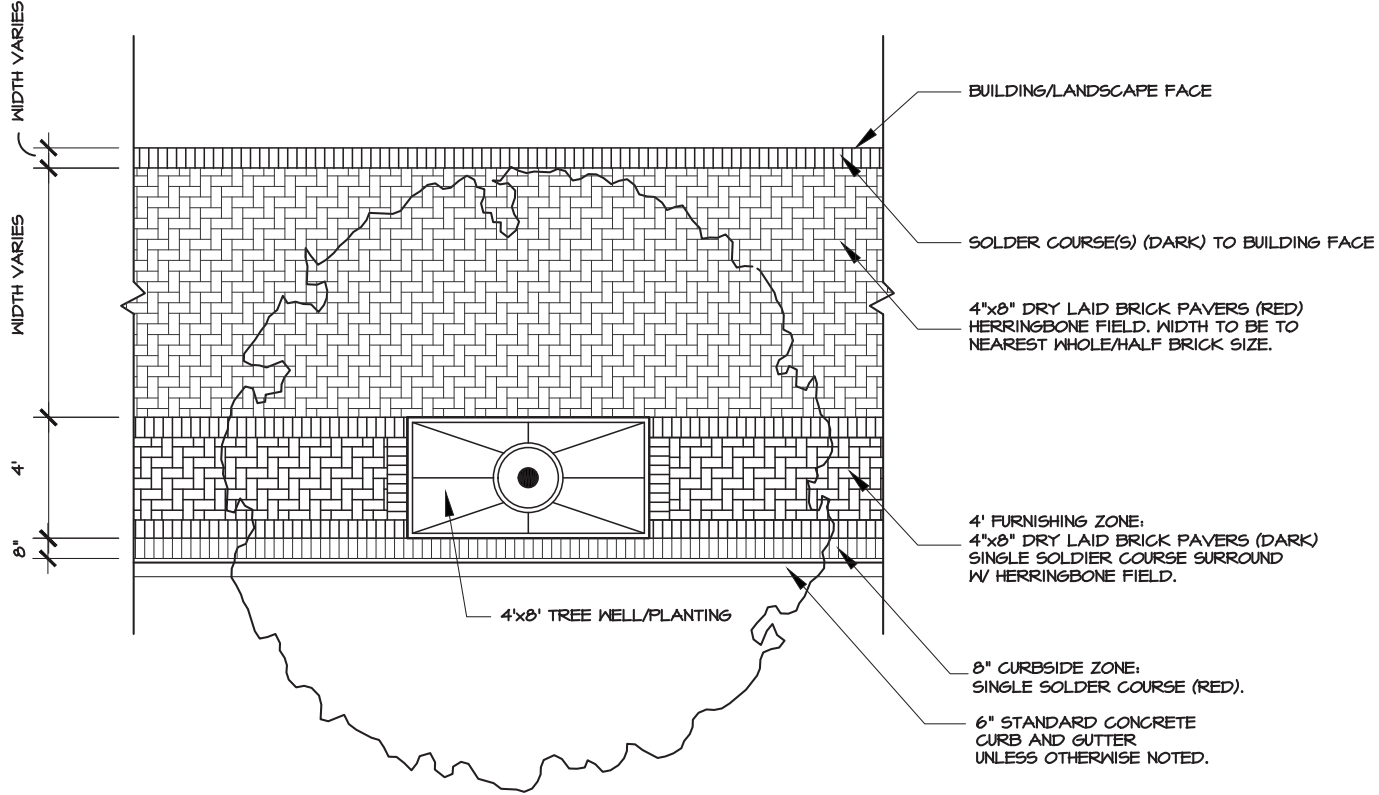

URBAN BRICK PAVING PATTERN  
NOT TO SCALE

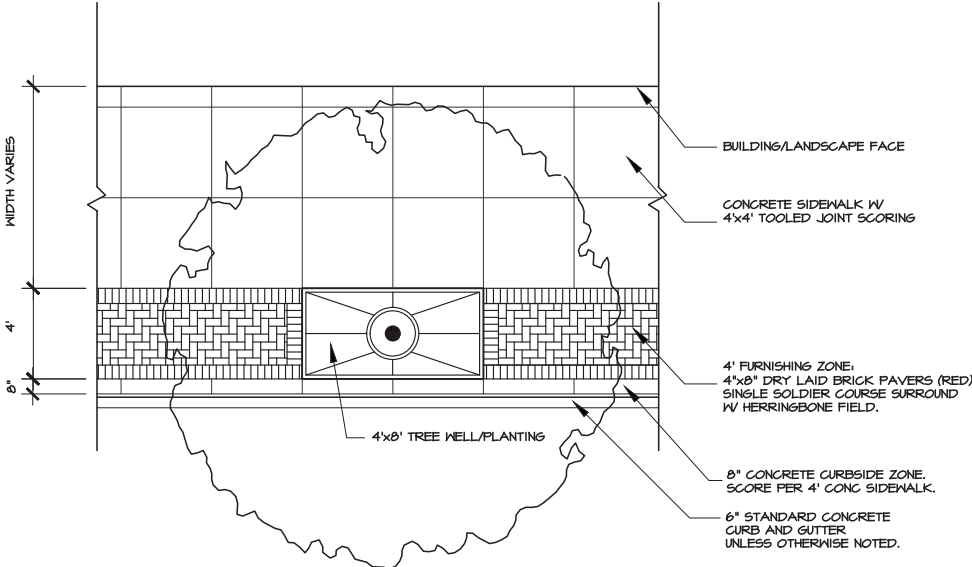

**URBAN BRICK/CONCRETE PAVING PATTERN**  
NOT TO SCALE

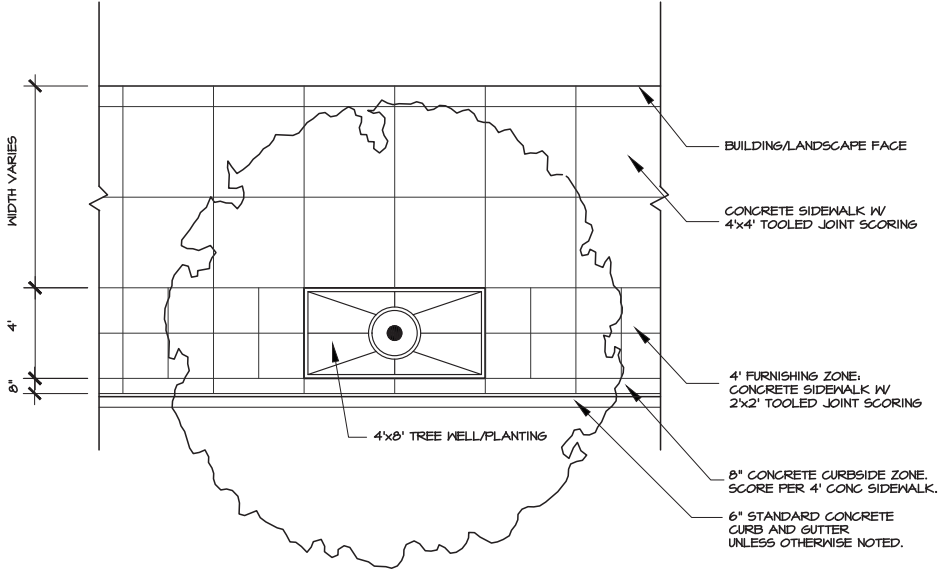

**URBAN CONCRETE PAVING PATTERN**  
NOT TO SCALE

Streetscape designs are to incorporate a suspended paving system. Suspended paving systems, also referred to as Stormwater Tree Cells, provide uncompacted subsurface soil to support healthy tree canopies and essential area within the right-of-way for stormwater collection in the urban environment.

Suspended paving systems should be designed to incorporate stormwater capture except where basements, vaults, or similar structures would create concerns with infiltrating stormwater. Where stormwater capture is a component of the suspended paving system, it should be designed to meet the performance standards set forth by ACHD and Boise City Public Works.

*Basis for Design:*

**SUSPENDED PAVING SYSTEM ORDER INFORMATION:**

DeepRoot Silva Cells 1-800-458-7668. Designed and installed per manufacturer's recommendations. Uncompacted soil volumes to be 500 cubic feet minimum per tree, or as required for stormwater management. Provide drip irrigation to cover entire modular suspended paving system. Optimal design to install suspended paving systems in a continuous fashion to provide shared soil volumes for street tree plantings to the greatest extent practicable. Soils to be per ACHD Bioretention Soil Media specifications. Coordinate drawings with ACHD to incorporate stormwater management into system.

Equivalent may be substituted as approved by Boise City and ACHD.





Bioretention Planter Example



Bioretention Swale or Bio-Swale Example

## GREEN STREET OPTION

Bioretention planters and bioswales are an acceptable alternative to a conventional tree lawn or landscape strip. Bioretention facilities help to treat stormwater runoff from the street and adjacent areas, thereby reducing pollutant discharge into the Boise River and providing street trees with some of the water they need. Bioretention facilities require different design from conventional tree lawns, including special soils and tree selection. Contact ACHD at (208) 387-6170 for details.

## DEFINITIONS:

**BIORETENTION PLANTERS** have vertical sidewalls and are often narrow and rectangular in shape. The walls allow bioretention planters to maximize the amount of stormwater retained within a small footprint. These facilities promote infiltration, storage, filtration, and attenuation of peak flows and volumes generated by specified storm events. The soil mix and plant species can be designed to remove targeted pollutants from stormwater.

**BIORETENTION SWALES** or **BIO-SWALES** are long, fairly shallow depressions that often use a curved or sinuous form to convey and slow water. They have a porous filter medium (usually soil-based) and are planted with native or non-native grasses and other vegetation. They work to treat stormwater by slowing and infiltrating flow and create an environment for plant uptake of pollutants. They enhance landscape aesthetics.

Street trees are selected to provide visual continuity along a single block face by using the same species. When planting new street trees, the trees should be the same species, of a similar caliper (trunk size), and placed at a consistent and even spacing within the block face. When replacing a sick or dead tree, the new tree should be the same species of the other street trees on the block unless otherwise specified, and it should be the largest caliper appropriate to facilitate continuity along the block face. Consult Boise City Community Forestry for tree species and before you plant, prune, or remove a tree, (208) 608-7700.

Grates shall be natural finish without powdercoating or paint. Grates shall meet ADA standards. In some cases, 6'x6' cast iron tree grates might be required to match existing.

Trees planted in tree well locations are to be incorporated with the suspended paving systems unless otherwise approved. See page 26 for Suspended Paving System description.

### *Basis for Design:*

#### **TREE GRATE AND FRAME ORDER INFORMATION:**

4' x 8' tree grates and frames. To be "Kiva" cast iron with natural raw finish by Urban Accessories. ADA compliant. Frames to be specified per surrounding paving type. All frames to have cross bars for frame support. Regional representative is Northwest Recreation, (877) 248-7770.

West End Tree Grates to be approved by Boise City.

Equivalent may be substituted as approved by Boise City.





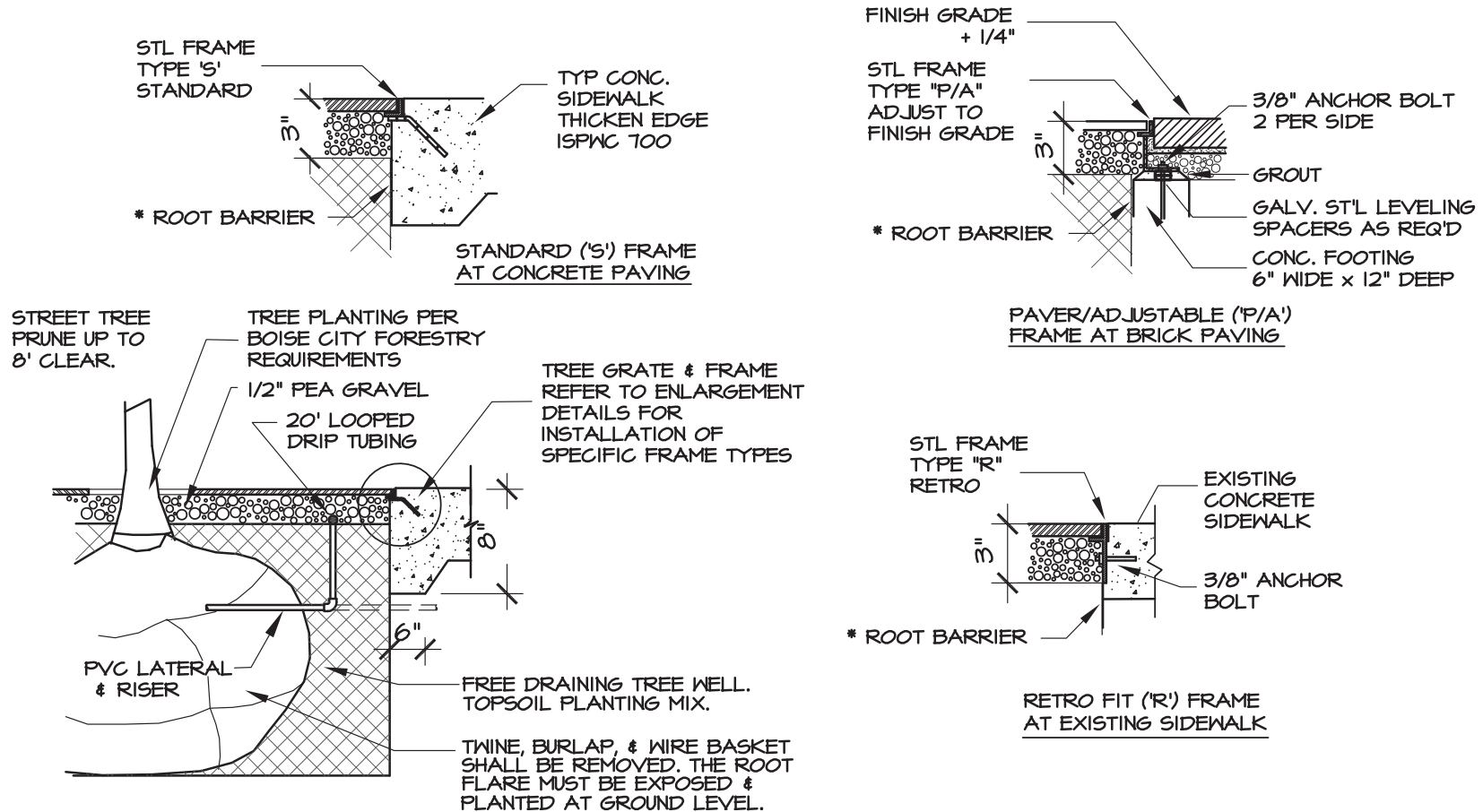

\* INSTALL BIOBARRIER ROOT BARRIER (OR APPROVED EQUAL) THAT EXTENDS 18" BELOW THE SUB GRADE ON THE SIDEWALK SIDE AND 24" BELOW THE SUB GRADE ON THE CURB SIDE.

4'x8' TREE GRATES AND FRAMES TO BE 'KIVA' CAST IRON WITH NATURAL RAW FINISH BY URBAN ACCESSORIES (OR EQUIVALENT AS APPROVED BY BOISE CITY). ADA COMPLIANT. FRAMES TO BE SPECIFIED PER SURROUNDING PAVING TYPE. ALL FRAMES TO HAVE CROSS BARS FOR FRAME SUPPORT.

CONTACT BOISE CITY FORESTRY (208) 608-7700 PRIOR TO PLANTING TO OBTAIN TREE PLANTING METHOD APPROVAL.

TREE WELL LOCATIONS TO BE INCORPORATED WITH THE SUSPENDED PAVING SYSTEMS UNLESS OTHERWISE APPROVED. REFER TO SUSPENDED PAVING SYSTEM DESCRIPTION FOR ADDITIONAL INFORMATION.

### TREE WELL SECTION

NOT TO SCALE

Trench grates may be used for trench drains that extend across sidewalk from building face to curb where other means of discharge conveyance, such as a direct pipe connection, are not feasible. These grates should be cast iron in the “RC” pattern, as manufactured by Urban Accessories.

Other trench grates may be approved by Boise City.

*Basis for Design:*

**TREE GRATE ORDER INFORMATION:**

All trench grates to be ‘RC’ pattern. Grate and frame to be cast iron in natural raw finish by Urban Accessories. ADA compliant. Width as required for proper water flow. Frames to be specified per surrounding paving type. Regional representative is Northwest Recreation, (877) 248-7770

West End Trench Grates to be approved by Boise City.

Equivalent may be substituted as approved by Boise City.



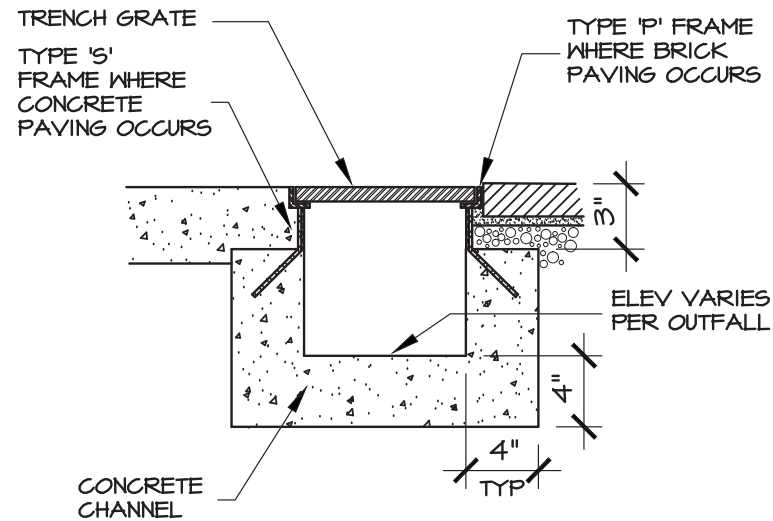

ALL TRENCH GRATES TO BE 'RC' PATTERN. GRATE & FRAME TO BE CAST IRON IN NATURAL RAW FINISH BY URBAN ACCESSORIES (OR APPROVED EQUIVALENT AS APPROVED BY BOISE CITY). WIDTH AS REQUIRED FOR PROPER WATER FLOW. FRAMES TO BE SPECIFIED PER SURROUNDING PAVING TYPE.

INSTALL GRATE FRAME WITH FLAT BAR RETAINER AT THE END OF THE TRENCH DRAIN AT THE CURB. IF FRAME DOES NOT HAVE STOP BAR, WELD STEEL FLAT BAR RETAINER TO END OF GRATE FRAME AT CURB.

## TRENCH DRAIN AND GRATE

NOT TO SCALE

Historic Streetlights to be placed centrally in the furnishing zone, and location and spacing shall be approximately 56'-64' apart (or as approved by Boise City Public Works Department) and in same alignment as trees. Lights to be centered between trees and conflicts with trees should be avoided. Historic Boise cast aluminum light poles with duplex outlets to be used. Provide separate 110v circuit for duplex outlet located at the top of luminaire.

Historic lights shall be equipped with a fixed top bracket, bolt-on banner arm, and lower eyelet. The banner arm shall be located 4" below top of pole and eyelet placed 51" below the arm, generally perpendicular to and facing the sidewalk. Some exceptions can be made for trees and other interfering infrastructure.

- All metal shall be powder coated green RAL 6009.
- Contact the Boise Public Works Municipal Lighting Technician at (208) 384-3900 for approval from Boise City.
- Contact the Downtown Boise Association (DBA) at (208) 385-7300 to learn more about the 24X50" banner program.

### HISTORIC STREETLIGHT ORDER INFORMATION:

Use the following link: <http://publicworks.cityofboise.org/development-permits-or-requirements/> and select "Street Light Design Standards" or "Street Light Design Checklist".



West End streetlights to be placed centrally in the furnishing zone and location and spacing shall be approximately 56'-64' apart (or as approved by Boise City Public Works Department), and in same alignment as trees. Lights to be centered between trees and conflicts with trees should be avoided.

Contact Boise Public Works Municipal Lighting Technician at (208) 384-3900 for approval from Boise City.

## *Basis for Design:*

### WEST END STREETLIGHT ORDER INFORMATION:

Antique Street Lamps 1-800-410-8899

EPAX Eurotique Aluminum Pole Series. 12' Ht, 4" dia shaft, Tenon for Arm  
EAL4, Natural Aluminum Finish. EPAX 12 S4 3-3/8T8 DNA

Eurotique Arms, One Luminaires, Natural Aluminum Finish

EAL4/1 DNA

Munich Pendant LED, Ringed Ballast Housing, 49 LED 350MA Source &  
Wattage, 4K Color Temp,

Glass- Clear Flat Lens, MVOLT Voltage, Type III Distribution, with Surge  
Protection Device, Natural Aluminum Finish

EML17 RT 49LED350MA 4K GCF MVOLT R3 SPD DNA

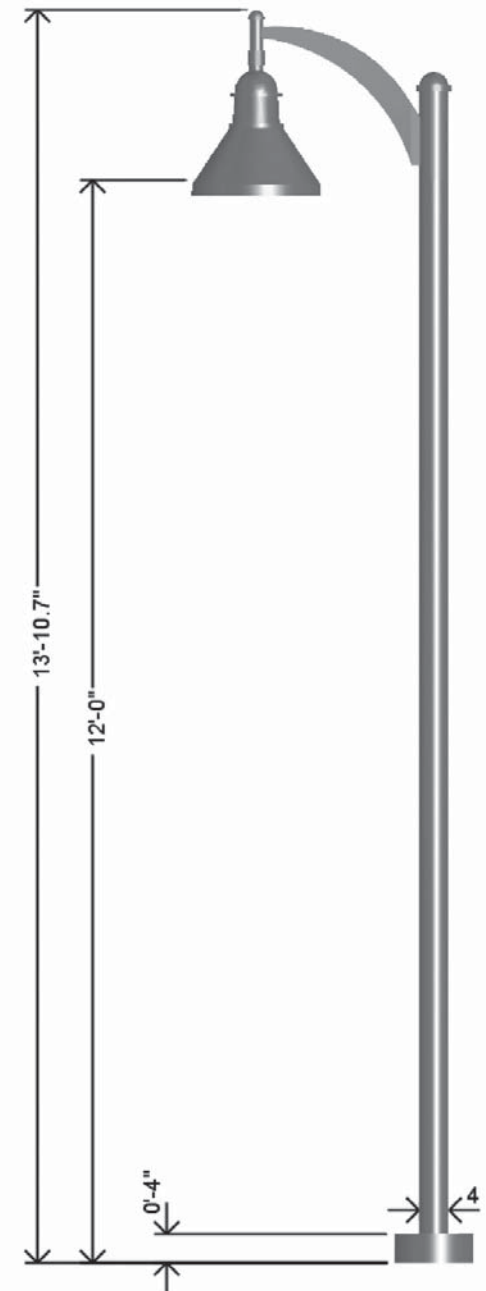

Public art is an art installation in the right-of-way or a public easement funded and/or maintained by a public agency. Public art enhances the downtown environment, offers social and educational opportunities, and promotes tourism. It can also be used to celebrate local artists and discourage vandalism. Capital City Development Corporation (CCDC) funds public art downtown on an ongoing basis, including standalone installations, installations with streetscape improvements, and innovative programs such as the traffic box art wraps.

Developers may propose a public art installation as an alternative component of a streetscape project. Any public art installation is subject to approval by Boise City (Arts & History and Planning & Development Services). Reimbursement by CCDC for a public art installation is subject to approval of a formal participation agreement by the CCDC Board, usually considered after the necessary approvals have been granted by the city. Art must be dedicated to the public prior to the granting of reimbursement by CCDC or the maintenance is undertaken by the city. A developer considering incorporating a public art installation as part of a streetscape improvement downtown should contact Boise City Department of Arts & History, (208) 433-5670 as early in the process as possible.

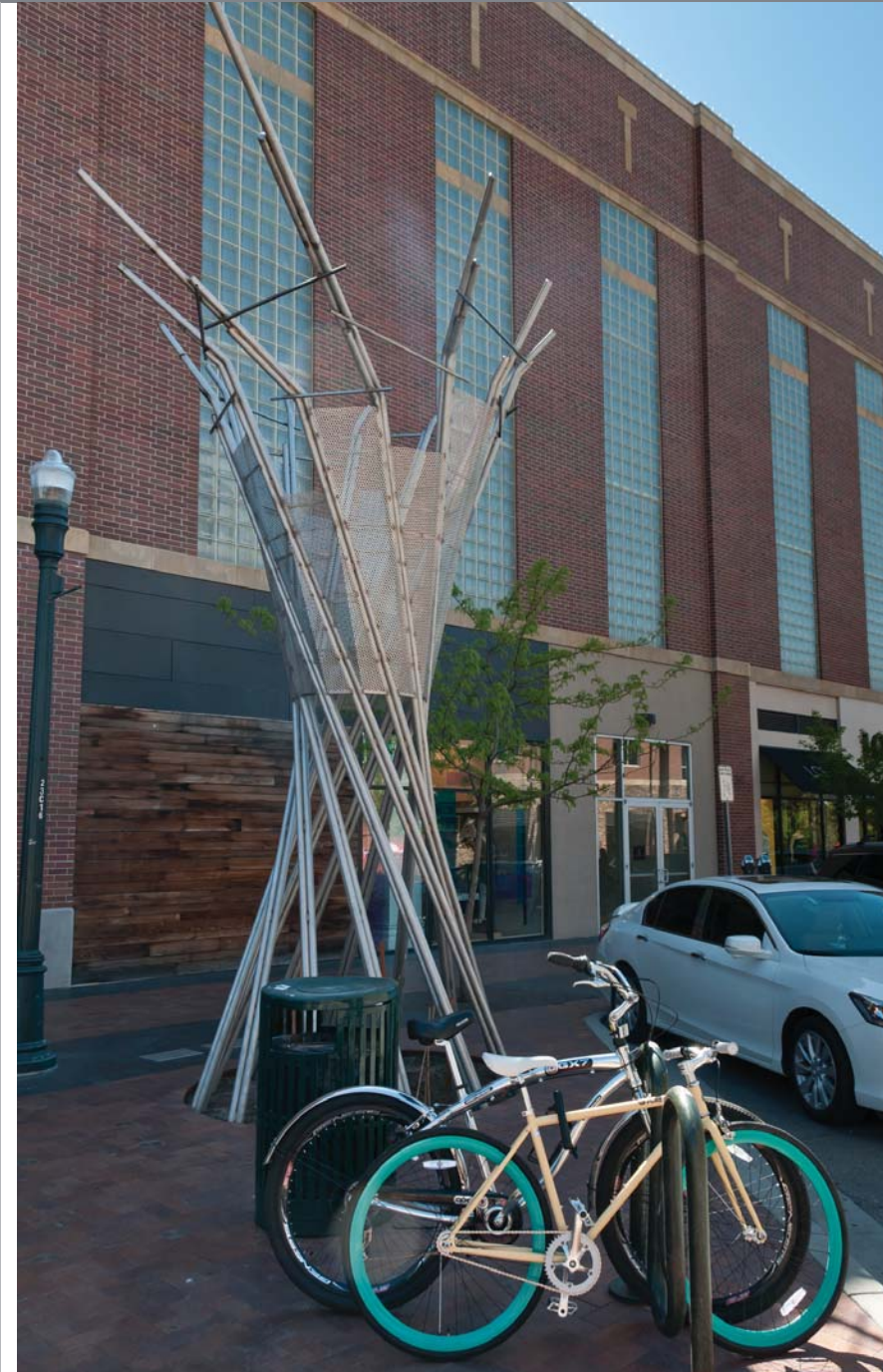

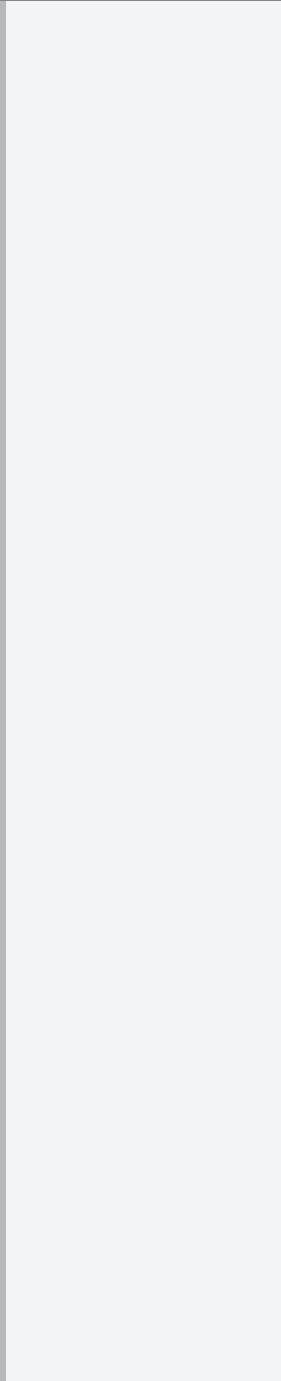

Benches are used in various configurations in the pedestrian furnishing zone. The typical length for benches is 4'. Lengths greater than 4' shall not be used without intermediate armrests or Boise City approval.

Benches have cast iron ends with wooden slats. All wood must be smooth finished and treated with Minwax Red Mahogany stain and penetrating sealer. A wood alternative for the slats may be used with approval from Boise City.

Location in the furnishing zone shall be as approved by Boise City or as shown on a streetscape plan approved by Boise City.

Surface mount with 1/2" x 2" expansion bolts.

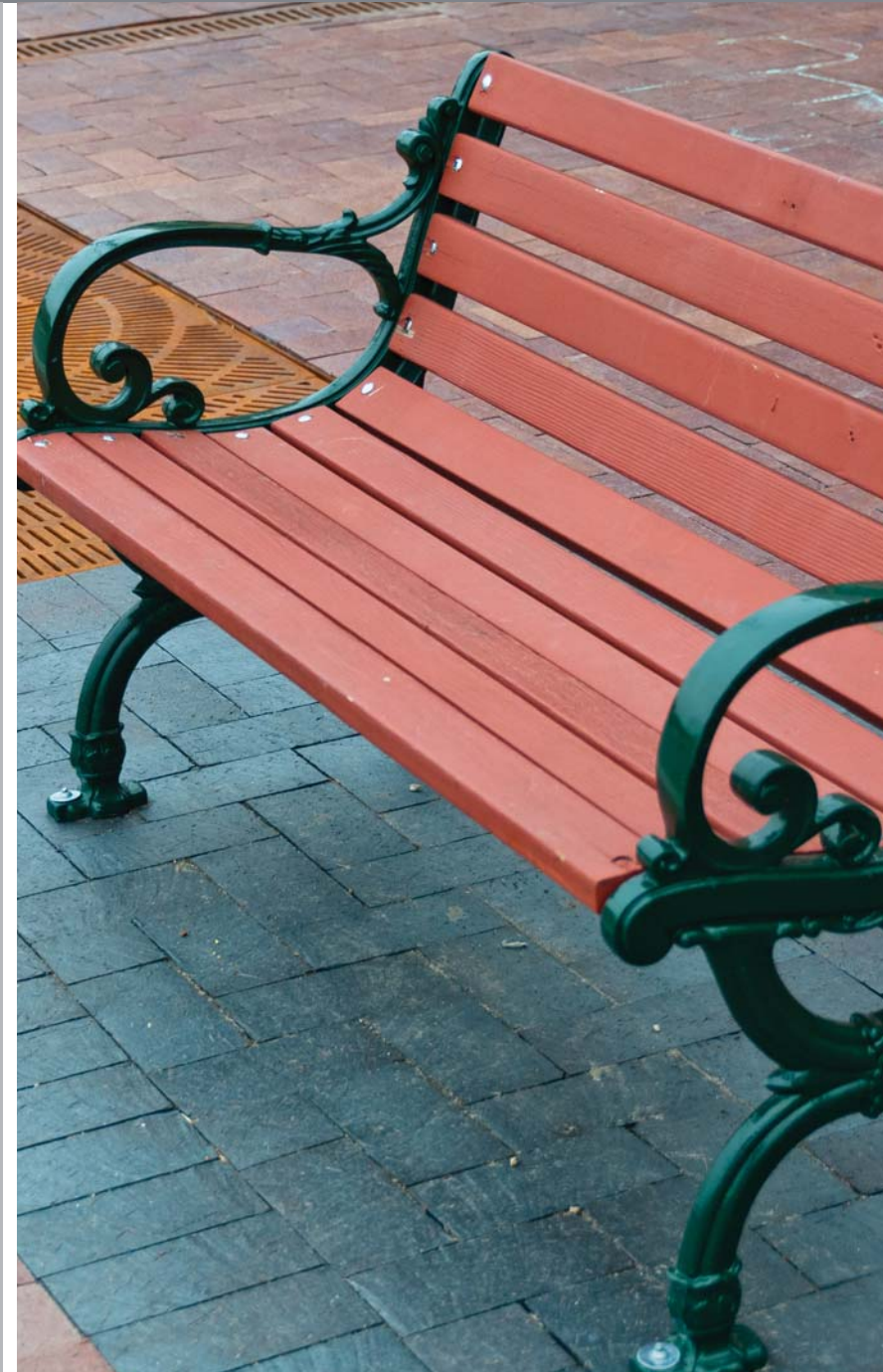

***Basis for Design:***

**BENCH ORDER INFORMATION:**

4 foot length, cast iron with wooden or recycled slats color - walnut . "Model C-10" by Victor Stanley, Inc., Dunkirk, MA, (301) 855-8300. Color RAL 6009.

Equivalent may be substituted as approved by Boise City.





Benches are used in various configurations in the pedestrian furnishing zone. The typical length for benches shall be 4'. Lengths greater than 4' shall not be used without intermediate armrests.

Location in the furnishing zone shall be as approved by Boise City or as shown on a streetscape plan approved by Boise City.

Surface mount with 1/2" x 2" expansion bolts.

*Basis for Design:*

**WEST END BENCH ORDER INFORMATION:**

4' or 6' Schenley bench with back. 6' to have center arm. Keystone Ridge 1-800-284-8208. Color to be Silver. Bolt in place.

Equivalent may be substituted as approved by Boise City.

Litter receptacles should be placed near seating areas and street corners where there is a high volume of pedestrian traffic. Location in the furnishing zone shall be as approved by Boise City or as shown on a streetscape plan approved by Boise City.

*Basis for Design:*

**LITTER RECEPTACLE ORDER INFORMATION:**

Chase Park model, side opening, with 36 gallon black polyethylene liner by Landscape Forms, Kalamazoo, MI. (800) 521-2546. Powdercoat color Ivy AG with graffiti resistant clearcoat. Surface mount with 3/8" anchor bolts (provided).

Equivalent may be substituted as approved by Boise City.



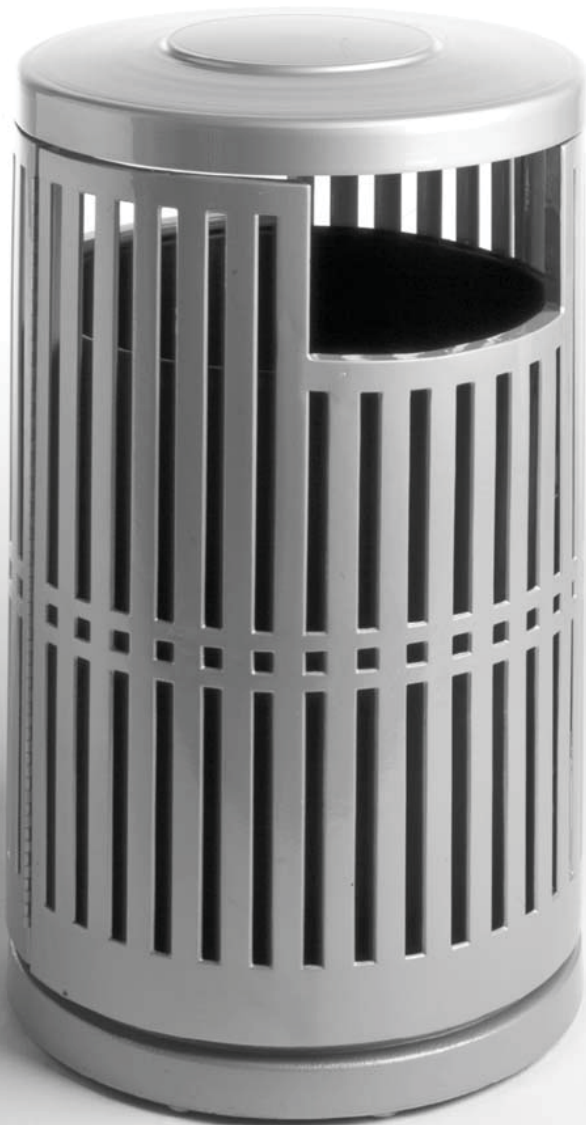

Litter receptacles should be placed near seating areas and street corners where there is a high volume of pedestrian traffic. Location in the furnishing zone shall be as approved by Boise City or as shown on a streetscape plan approved by Boise City.

*Basis for Design:*

**WEST END LITTER RECEPTACLE ORDER INFORMATION:**

Chase Park model, side opening, with 36 gallon black polyethylene liner by Landscape Forms, Kalamazoo, MI. (800) 521-2546. Powdercoat color Silver AG with graffiti resistant clearcoat. Surface mount with 3/8" anchor bolts (provided).

Equivalent may be substituted as approved by Boise City.

Bicycle racks should be located in the pedestrian furnishings zone at locations throughout areas which attract cyclists. Bike racks should be a “single bend”. Location in the furnishing zone shall be as approved by Boise City or as shown on a streetscape plan approved by Boise City.

Bike racks within the 4’ wide furnishing zone are to be placed parallel with the adjacent street. In areas where furnishing zone may be 6’ or wider and outside of the pedestrian zone, bike racks may be placed perpendicular with the adjacent street.

***Basis for Design:***

**BIKE RACK ORDER INFORMATION:**

‘Single Bend’ bike rack. From KB Fabrication and Welding Inc. (208) 898-9353. Color RAL 6009.

West End Bike Rack to be same style: Finish to be galvanized

Equivalent may be substituted as approved by Boise City.



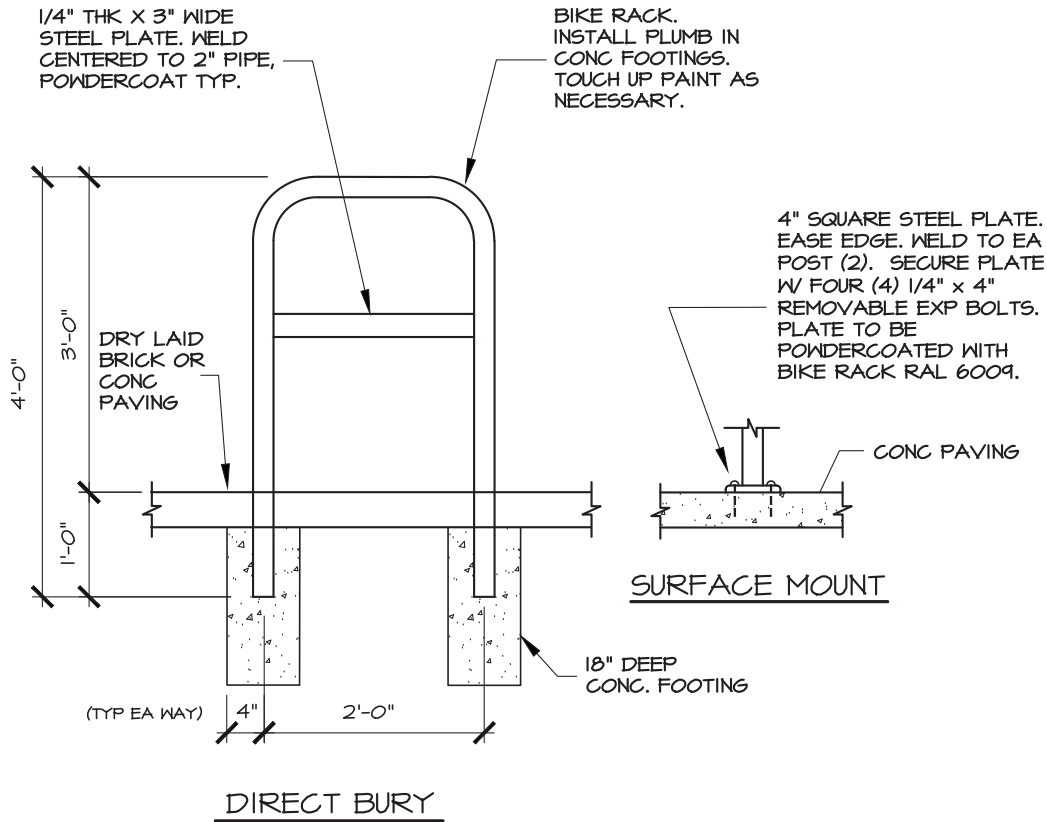

**NOTE:**  
BIKE RACK TO BE 2" ROUND SCH 40 STEEL PIPE; BEND TO FORM & DIMENSIONS AS SHOWN. POWDERCOAT RAL-6009.

## BIKE RACK

NOT TO SCALE

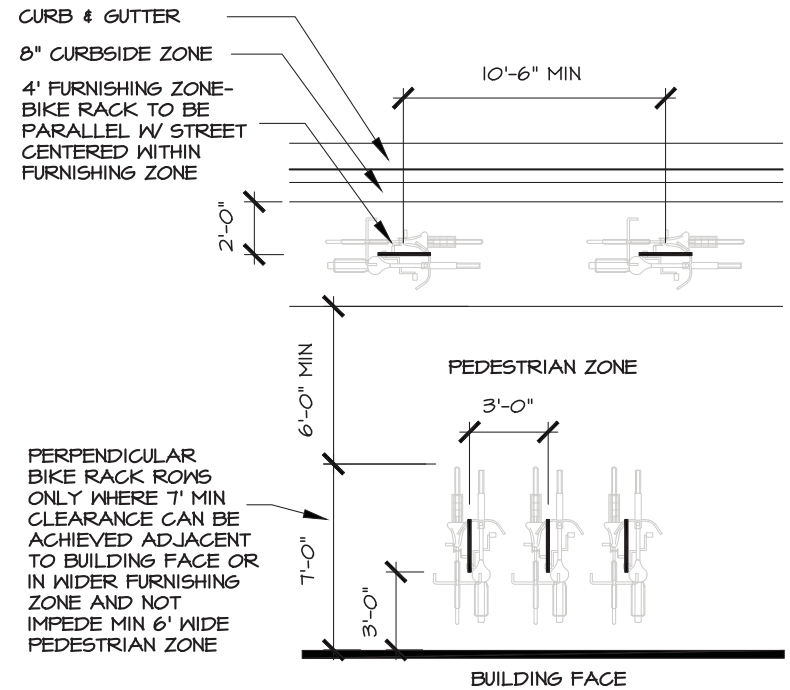

## BIKE RACK SPACING

NOT TO SCALE

Bicycle corrals are multi-bike parking structures which are placed in a standard parking space next to a sidewalk and curb. The advantages of corrals are that they can hold up to 20 bicycles in areas where there is high demand for bike parking, they free up valuable sidewalk space, and they are typically situated in highly visible areas so as to discourage theft and vandalism. The corrals are made locally and can be easily moved as the need arises.

Capital City Development Corporation (CCDC) will consider requests to provide and install bike corrals on a case by case basis. Requests should be submitted in writing from property owners, businesses, and/or residents adjacent to the proposed corral site. Location of corrals are subject to approval by Boise City and ACHD.

## *Basis for Design:*

### **BIKE CORRAL ORDER INFORMATION:**

Contact CCDC, (208) 384-4264 for order information.

Color RAL 6009.

Equivalent may be substituted as approved by Boise City.

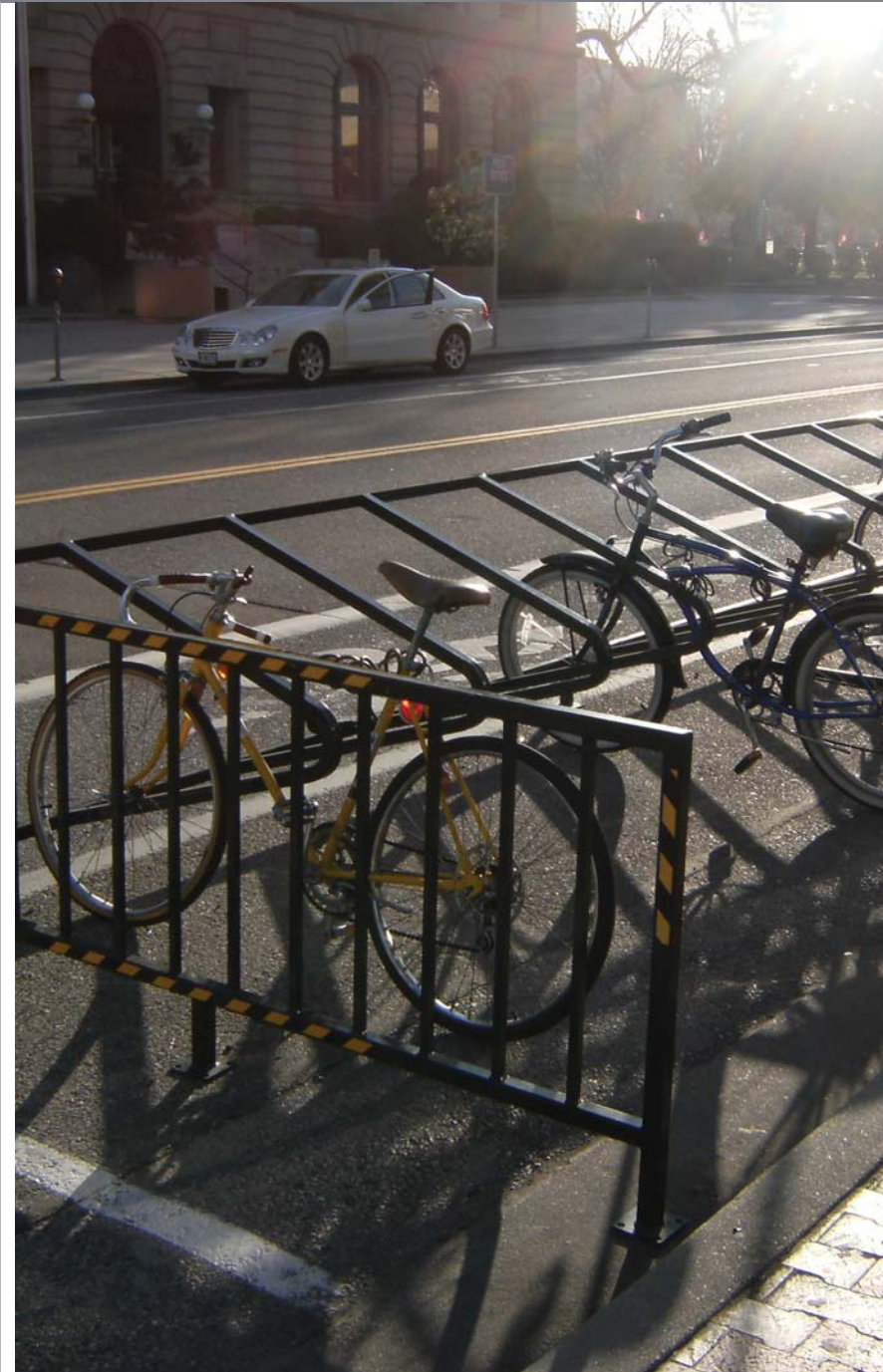

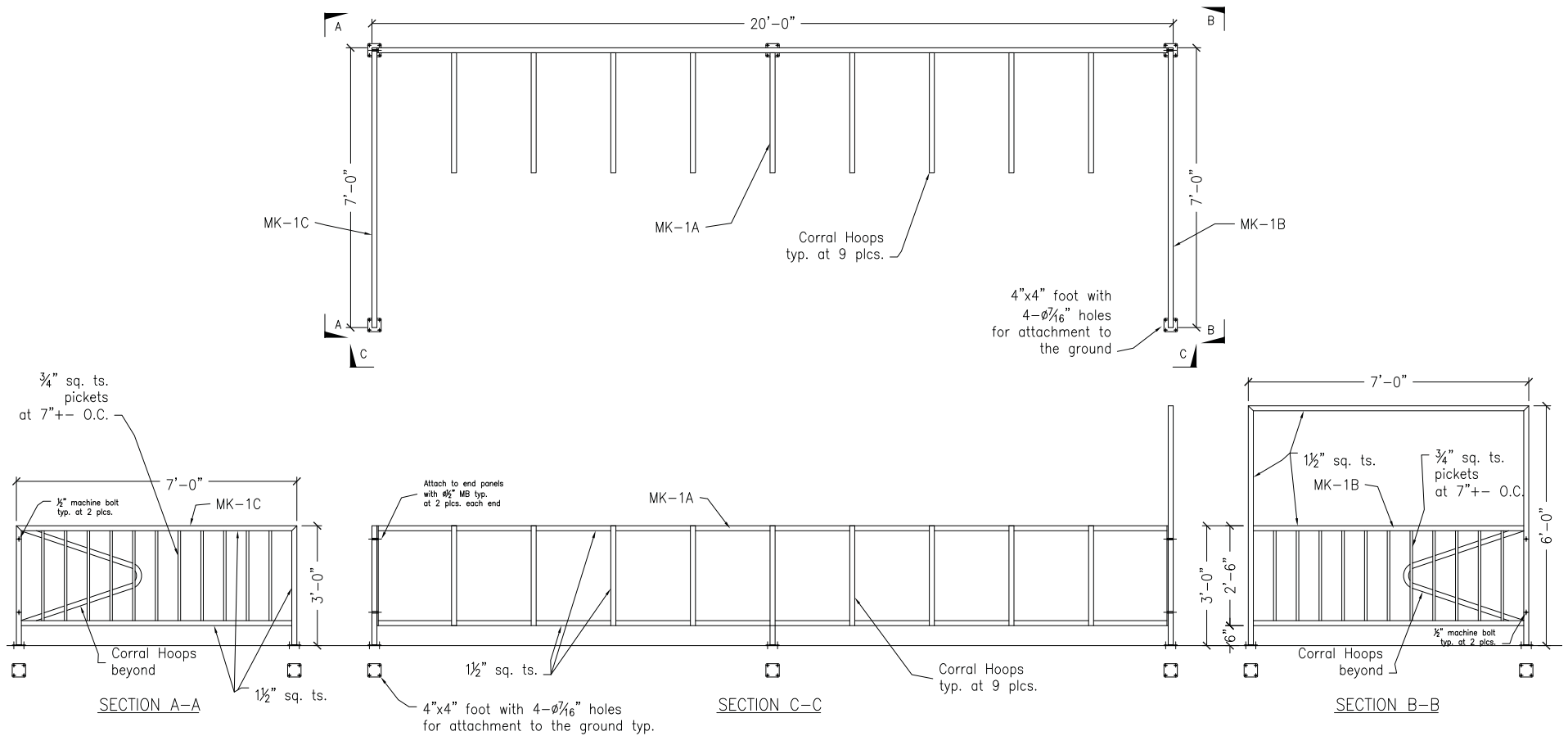

Movable planters shall be 3' in diameter and 17" high or as approved by Boise City. Location in the furnishing zone and spacing shall be as approved by Boise City or as shown on a streetscape plan approved by Boise City.

The Downtown Boise Association (DBA) manages the flower program for the downtown Boise business improvement district (South of State Street, north of Myrtle Street, east of 13th and west of 5th Street). Planters are filled with flowers from May through early November and are funded by the Business Improvement District assessments after the first year's assessments are paid by the property owner.

Contact the DBA for details about flower planting program, (208) 385-7300.

*Basis for Design:*

**MOVABLE PLANTER ORDER INFORMATION:**

Standard 3' round x 17" height cast stone planter by Idaho Precast Concrete, Nampa, ID (208) 461-6300.

West End Movable Planter to be approved by Boise City.

Equivalent may be substituted as approved by Boise City.





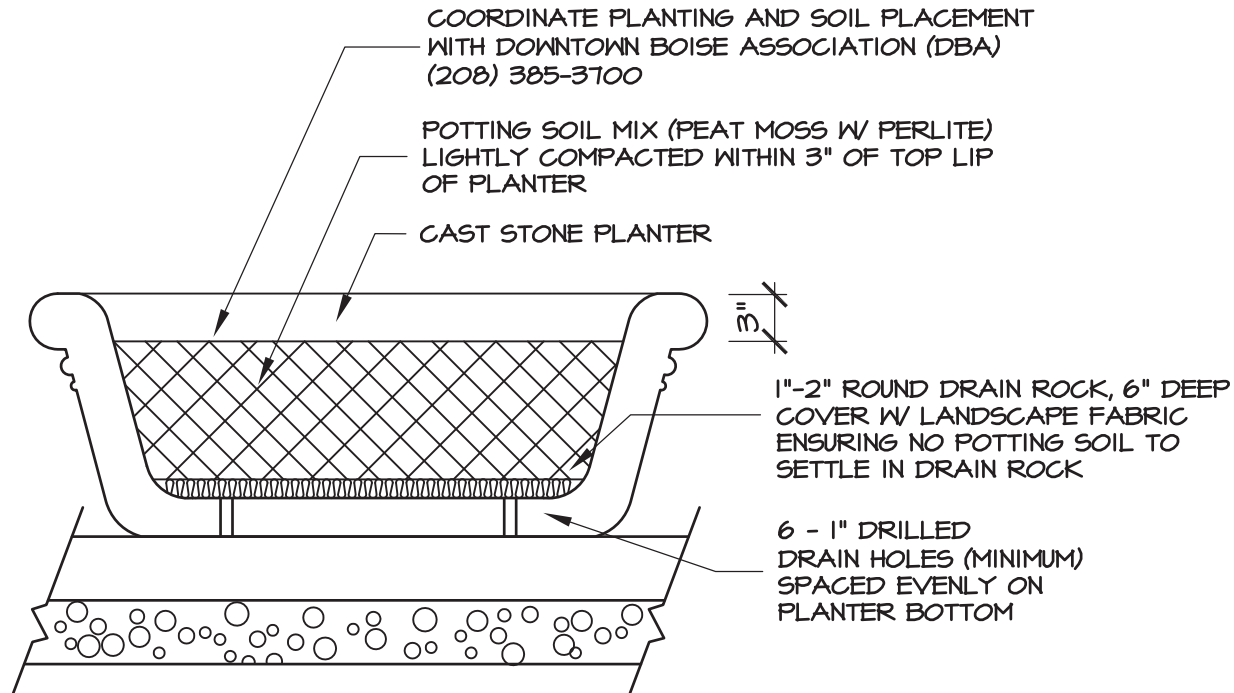

3-FOOT ROUND x 17-INCH HEIGHT CAST STONE PLANTER.  
BY IDAHO PRECAST CONCRETE, NAMPA, ID (208) 461-6300.  
OR EQUIVALENT AS APPROVED BY BOISE CITY.

## MOVABLE PLANTER

NOT TO SCALE

Tree guards are purchased by CCDC and installed on new trees in high pedestrian and bike traffic areas to protect the trees from bikes and vandalism until they are established.

Contact CCDC, (208) 384-4264 for installation.

*Basis for Design:*

**TREE GUARD ORDER INFORMATION:**

RR model tree guard by Urban Accessories, Tacoma, Washington. Color to be RAL 6009. Regional representative is Northwest Recreation, (877) 248-7770.



Tables are used in strategic locations to enhance the urban experience. Boise City to approve location and layout.

*Basis for Design:*

**TABLE ORDER INFORMATION:**

Steelsites Series SPCT-30 Steel Square Cafe Table (30") and FTRS-24 Steel Scroll Seats (24" wide) without backs, RAL 6009, surface or in ground mount. Victor Stanley  
(301) 855-8300.

West End Table to be approved by Boise City.

Equivalent may be substituted as approved by Boise City.



Bollards should be used to define special areas and to enhance pedestrian safety at vehicular crossings. They may also be used along the curbside edges of sidewalks on high volume streets to promote a greater sense of safety for pedestrians.



*Basis for Design:*

**BOLLARD ORDER INFORMATION:**

1890 Series cast iron fixed and removable bollard by Canturbury International, Los Angeles, CA (800) 935-7111. Color RAL 6009.

West End Bollard to be approved by Boise City.

Equivalent may be substituted as approved by Boise City.

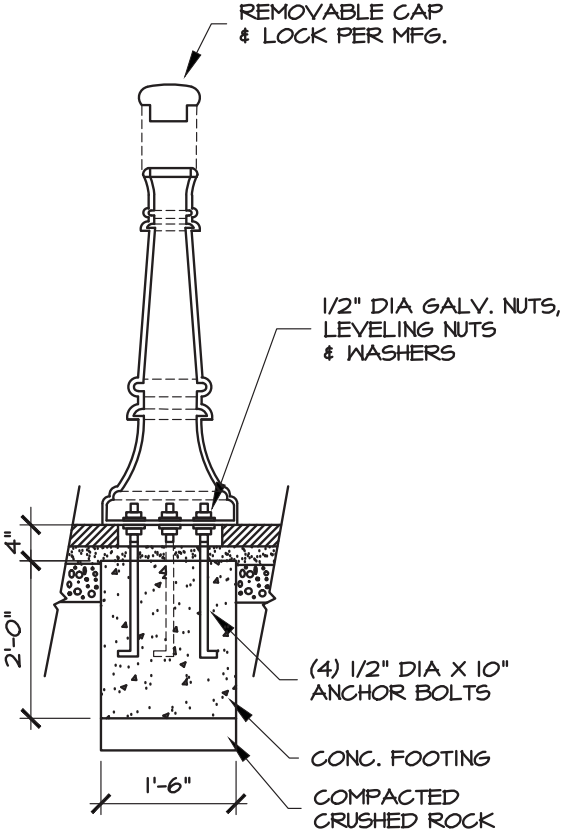

BOLLARD: 1890 SERIES CAST IRON FIXED AND REMOVABLE BOLLARD BY CANTURBURY INTERNATIONAL, SHERMAN OAKS, CA (800) 935-7111.

BOLLARD

NOT TO SCALE

The design standard for the transit shelters that are located in the Downtown Boise Transit Mall was revised in 2009 and replaces the original design standard established in 1986.

The same design standard should be used for transit shelters in the downtown area. Placement and installation are approved by Valley Regional Transit.

## TRANSIT SHELTER ORDER INFORMATION:

Contact Valley Regional Transit, (208) 258-2705.



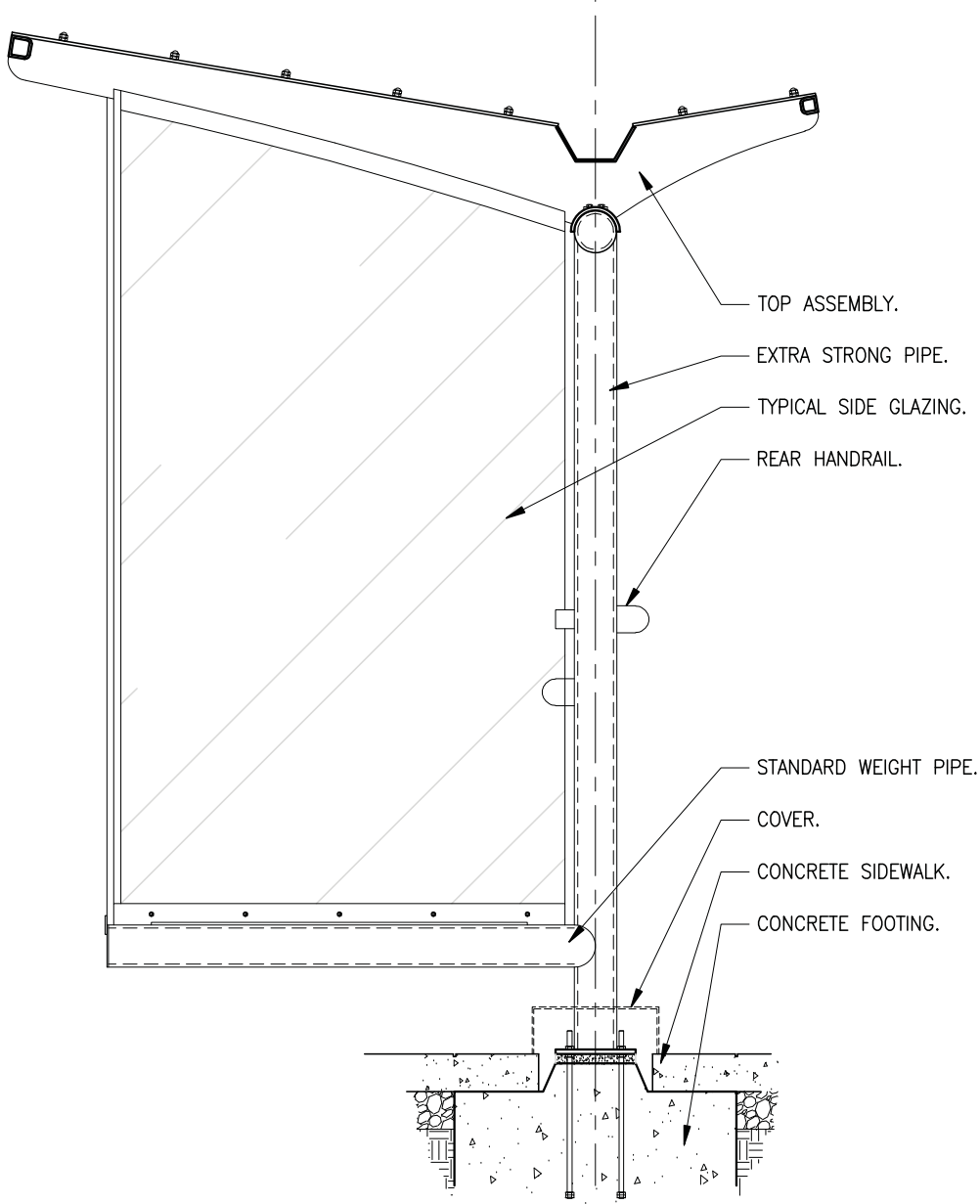

Refer to Valley Regional Transit Bus Stop Location and Transit Amenities Development Guidelines for transit shelter requirements and details.

Drinking fountains should be used in the pedestrian furnishings zone in areas of high pedestrian activity.

*Basis for Design:*

**DRINKING FOUNTAIN ORDER INFORMATION:**

Domestic water hookup and freeze-proof installation per manufacturer details and prevailing code.

Equivalent may be substituted as approved by Boise City.





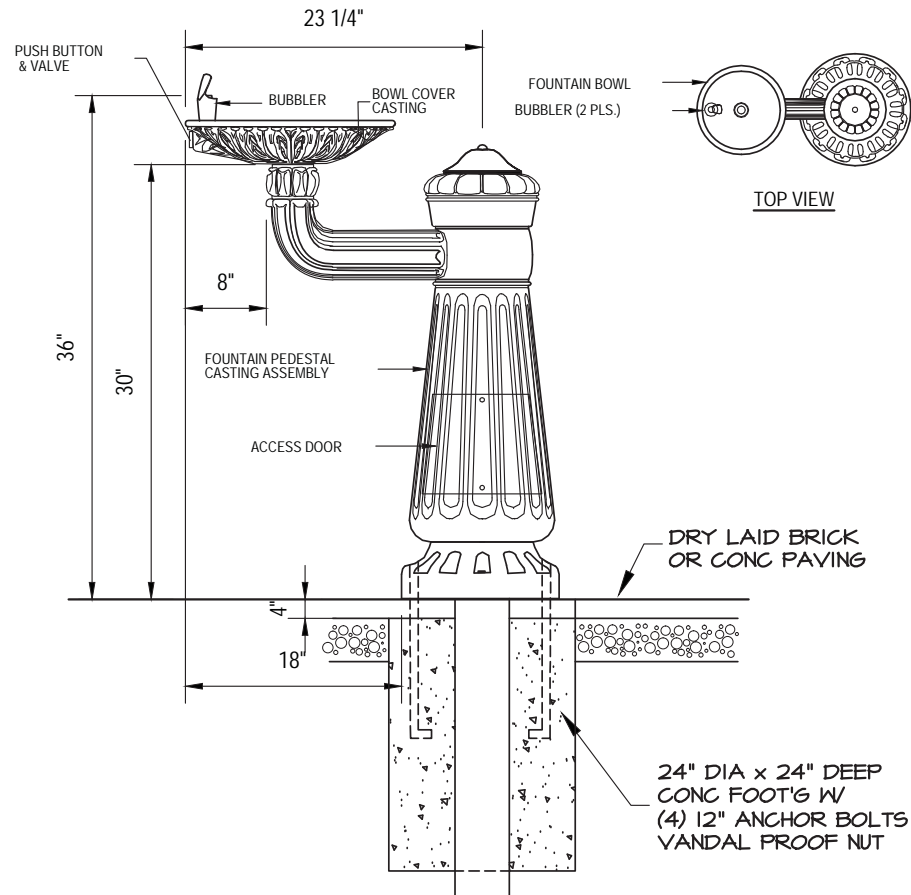

**NOTES:**

1. DRINKING FOUNTAIN WITH CAST IRON PEDESTAL TO BE MODEL 1890 BY CANTERBURY INTERNATIONAL (800) 935-7111. PAINT RAL 6009.
2. PROVIDE/INSTALL APPROVED FREEZEPROOF STOP & WASTE AND ALL SUPPLY & DRAIN PER I.S.P.W.C.

## DRINKING FOUNTAIN

NOT TO SCALE

### STREET TREES

Trees must be approved by Boise City Community Forestry. A Boise City Forester will approve the caliper classification (size) and species appropriate to each project. Street trees must have a 2-1/2" minimum trunk diameter at the time of installation, be balled and burlapped, and be well formed with no branches below 8' height in pedestrian use areas. Trees must be nursery grown and installed by a qualified landscape professional. Planting soil must be a well draining blend of pH balanced topsoil and composted amendments. Remove twine and pull back burlap to expose root flare. Plant exposed root flare at finish grade. Street trees must be watered from an automatic irrigation system, with drip tubing for tree wells, and pop-up sprinklers for trees in lawn strips. Boise City Community Forestry requires a tree planting demonstration during first tree installation to obtain planting method approval, (208) 608-7700.

### LANDSCAPE IRRIGATION

All street trees and landscaping must be watered with an automatic underground drip irrigation system. Hookup must be in compliance with local plumbing codes for protection of the domestic water supply. The system must be designed and installed by a qualified landscape professional utilizing water conservation techniques. All supply piping under paved surfaces must be inside rigid conduit and all valves in the public right-of-way must be in traffic rated boxes. The system must include provision for winterization.

Irrigation systems will be installed on the adjacent property owners water line. Property owner is responsible for all yearly maintenance, operation, and repair of the irrigation system, including spring start-up, seasonal monitoring, and winterization of the system.

### LAWN SOD

Provide lawn sod composed of 80% Bluegrass varieties and 20% Perennial Ryegrass, delivered from a certified sod grower at the time of planting. Preparation of the planting soil will consist of placing a 6" well draining blend of pH balanced topsoil and composted amendments. The soil must not be saturated or frozen. Install the sprinkler circuit for complete coverage either before or after soil preparation, and finish grade the surface from sidewalk to curb elevation minus 1-1/2" to account for the sod thickness. Lightly moisten the soil surface. Lay the sod in unbroken strips with tight joints, fertilize, and irrigate thoroughly.

### PLANTS

Provide plants that are hardy to USDA Plant Hardiness Zone 5 and are of drought-tolerant varieties with varying seasonal interest. Provide shrubs that comply with recommendations and requirements of ANSI Z60.1 "American Standard for Nursery Stock". Provide 1 gallon or larger container shrubs not less than minimum number of canes required by ANSI Z60.1 for type and height of shrub. Height to be no more than 3' within ROW. Mulch for planting beds shall be 3" thick medium ground bark mulch, free of splinters, consistent in appearance, and shall contain no toxic substance detrimental to plant life.

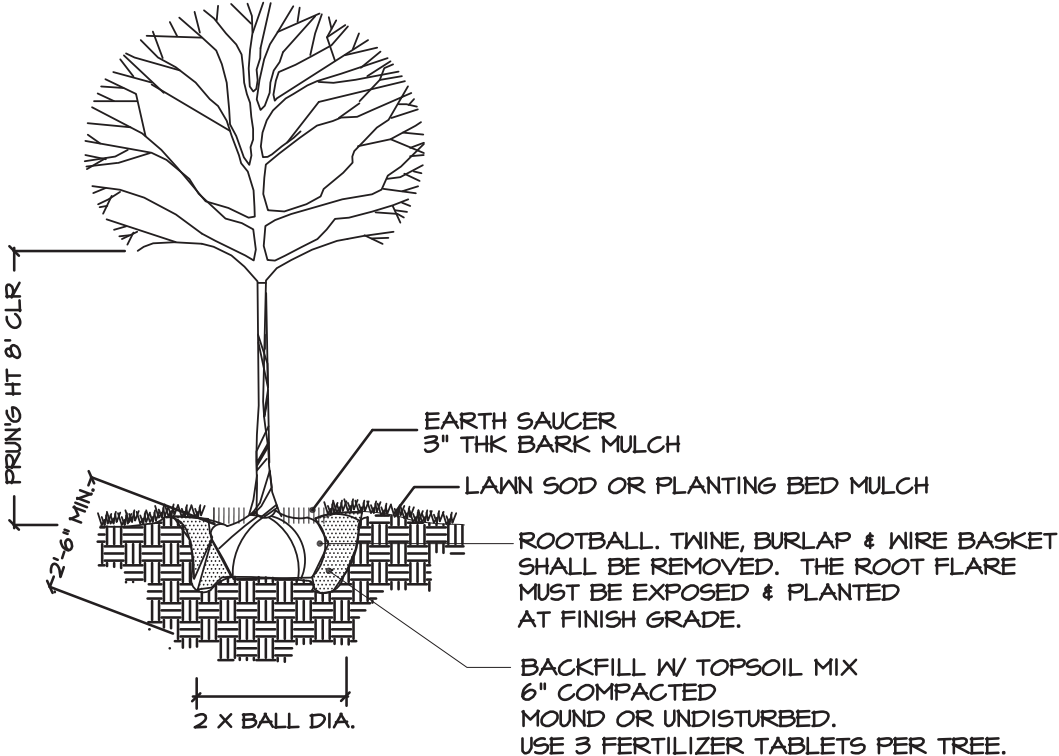

CONTACT BOISE CITY FORESTRY (208) 608-7100 PRIOR TO PLANTING TO OBTAIN TREE PLANTING METHOD APPROVAL.

## TREE PLANTING

NOT TO SCALE

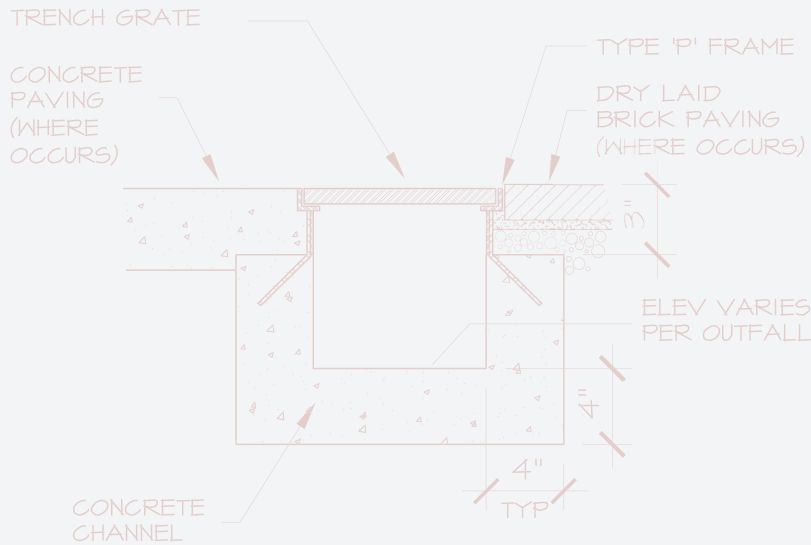

BLDG FACE

JOINT SEALANT

ALL TRENCH GRATES TO BE 'RC' PATTERN.

GRATE & FRAME TO BE CAST IRON BY URBAN ACCESSORIES.  
REGIONAL REPRESENTATIVE: NORTHWEST RECREATION (877-248-7770)

BACKER ROD

PAVING (BRICK OR CONC) PER PLANS

BITUMINOUS JOINT FILLER

TRENCH DRAIN AND GRATE

NOT TO SCALE

PRUN'G HT 6' CLR

2'-6" MIN.

TYP CONC SIDEWALK PER ISPNG TOO

BRICK PAVER

SAND BASE & JOINT FILLER

FINISH SAND 1/4"

EARTH 3" THK

LAWN

2 X BALL DIA.

CRUSHED ROCK SUBBASE

This page intentionally left blank.

FACE





# 4

## Find the Quality Control Standards & Conditions for Your Streetscape Project

All construction on streetscape projects shall conform to current Idaho Standards For Public Works Construction (ISPWC), Ada County Highway District's Standard Supplemental Specifications and Standard Drawings, the City of Boise's Supplemental Standard Specifications, and Valley Regional Transit's Bus Stop Location and Transit Amenities Development Guidelines.

The Streetscape Project shall be constructed in accordance with the overall City of Boise infrastructure plans, policies, and design standards and with this Downtown Boise Streetscape Standards Manual.

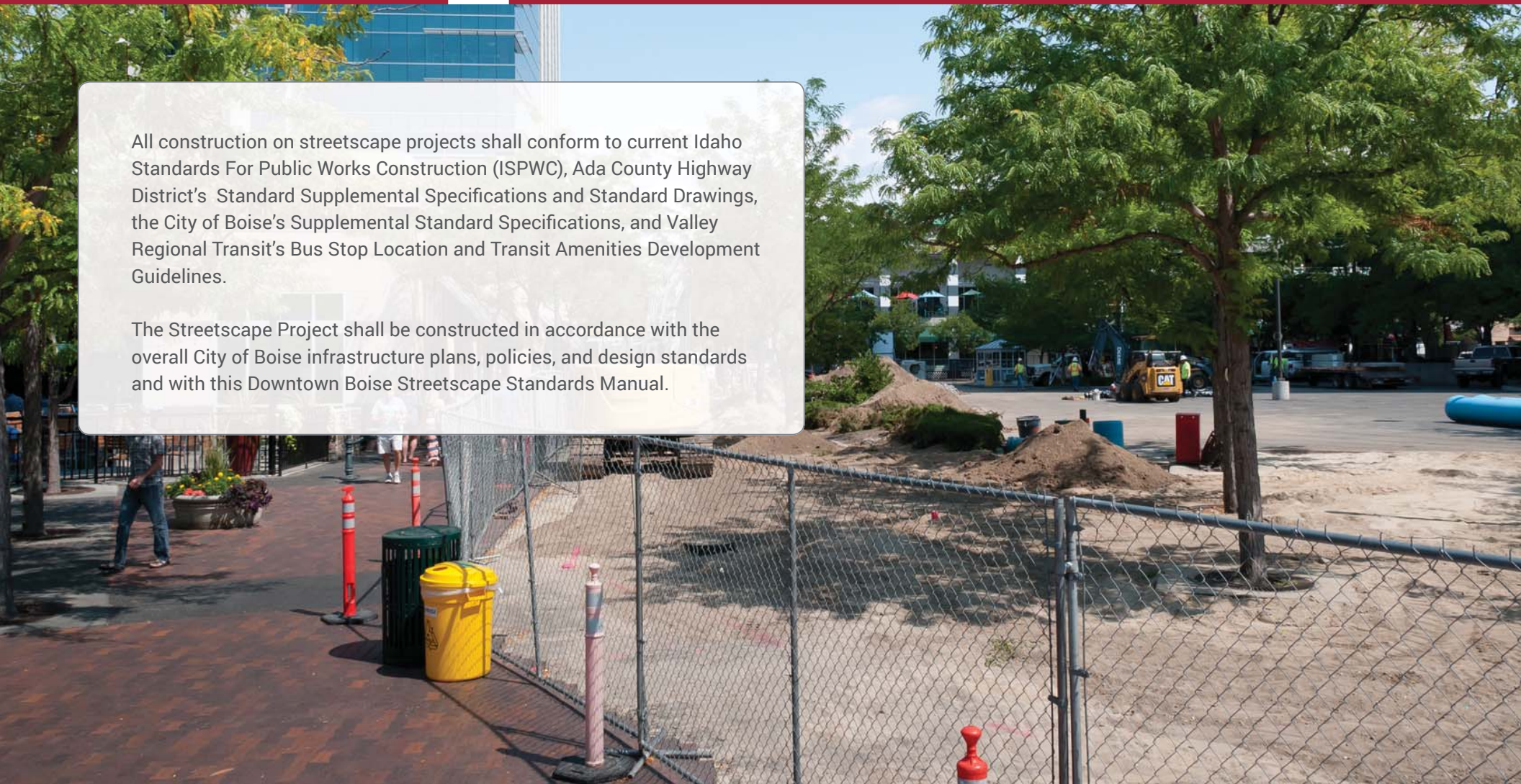

# General Requirements

## CONSTRUCTION COORDINATION

- The Developer shall schedule and attend:
  - » The Contractor shall coordinate construction with CenturyLink, United Water Idaho, Boise City Public Works Department, ACHD (signal interconnect), Idaho Power Company, and Intermountain Gas Company. Extreme care must be maintained when working in the vicinity of utility lines. The Contractor shall retain and protect all utilities, including electrical facilities, within the project limits not specifically identified for abandonment or relocation.
  - » The Contractor shall coordinate with these utilities, with ACHD and/or ITD, and their contractors as applies and Valley Regional Transit as needed, and keep them informed of the schedule and any pertinent changes.
- Working Hour Traffic
  - » Avoid disturbance of rush hour traffic between 7-9am and 4-6pm on all fronting streets.
  - » The Contractor will be required to obtain Right-Of-Way Permits from Ada County Highway District (ACHD) and/or Idaho Transportation Department (ITD) if needed. Contractor shall coordinate all work on active transit routes with Valley Regional Transit (VRT) through the construction schedule.

## CONTACT INFORMATION

CCDC Participation Program	Capital City Development Corp. (208) 384-4264
Streetlight Coordination	Boise City Public Works Dept. Municipal Lighting Technician (208) 384-3900 / 388-4719
Parking Meter Coordination	Boise City Parking Control (208) 384-3700
Street Tree Coordination	Boise City Community Forestry (208) 608-7700 <a href="mailto:bpr@cityofboise.org">bpr@cityofboise.org</a>
Movable Planter Coordination	Downtown Boise Association (208) 385-3700
Transit Stops and Shelters	Valley Regional Transit (208) 258-2705
Fire Hydrants	Boise City Fire Department (208) 570-6500
Work within Rights-of-Way	Ada County Highway District Development Services Dept. (208) 387-6170
Telephone	CenturyLink Communications (208) 385-2903
Electric	Idaho Power Company (208) 388-6320
Gas	Intermountain Gas Company (208) 377-6846 <a href="mailto:customerservice@intgas.com">customerservice@intgas.com</a>
Water Service, Valves	United Water Idaho (208) 362-7355 / 362-7329

## CONSTRUCTION SCHEDULE

In order to minimize impacts on existing businesses under renovation the Contractor shall conduct his operation to meet the following schedule restrictions:

- The Contractor shall restrict parking space closure to four spaces at any given time and only as authorized by Boise City, (208) 384-3700.
- Projects Administered by a Developer: The Contractor and construction operation shall not prevent access to occupied businesses during business hours. Pedestrian access shall be provided to business during business hours, and in a safe direct manner at all times during construction. If it is necessary to interrupt access to any business, the Contractor shall coordinate as necessary with the affected business and the developer.
- Projects Administered by CCDC: The Contractor and construction operation shall not prevent access to occupied businesses during business hours. Pedestrian access shall be provided to business during business hours, and in a safe direct manner at all times during construction. If it is necessary to interrupt access to any business, the Contractor shall obtain written permission from the affected business, and notify the CCDC Project Manager, (208) 384-4264.

## CONTRACTOR'S RESPONSIBILITIES

- Coordinate Historic Streetlight installation with the Street Light Technician at Boise City Public Works, at least five working days prior to disruption of streetlights or circuits.
- All contract and adjacent areas impacted by construction shall be thoroughly cleaned at the completion of work.
- The Contractor is responsible for obtaining permits, and calling for relevant permit inspections.

- The Contractor is responsible for paying for storage facilities during construction.
- It is the Contractor's responsibility for material pickup, delivery, and transport to the site.
- The Contractor is responsible for providing water, electrical, and sanitary facilities for workers and construction activities.
- If the project has received a Streetscape Grant from CCDC (explained below), the Contractor shall provide developer with itemized invoices for the items on the cost estimate submitted with the grant application.
- The Contractor shall coordinate all work zone effects on transit routes or stops with Valley Regional Transit at least two weeks prior to project commencement if route detours are needed and 48 hours prior to project commencement if construction will occur in the Right-of-Way where routes operate.

## CONDITIONS OF GRANT PAYMENT (IF APPLICABLE)

In accordance with the Capital City Development Corporation (CCDC) Streetscape Grant Agreement:

- The Developer submits a Letter of Completion with invoices or receipts of streetscape work within thirty days of completion of the Streetscape Project.
- CCDC performs a final streetscape inspection.
- CCDC reviews and approves invoices. Grant is paid in accordance with the approved participation agreement.
- Go to [www.ccdchoise.com](http://www.ccdchoise.com) for a streetscape grant application or call, (208) 384-4264.

FRAME & GRATE  
PER PLAN. TYPE 'S'  
STANDARD

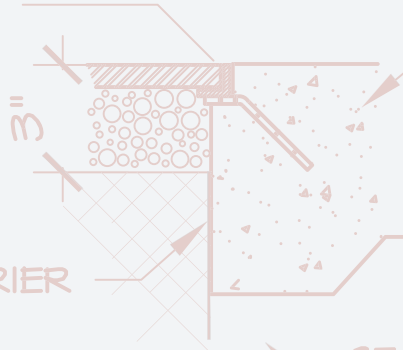

TYP CONC.  
SIDEWALK  
THICKENED EDGE  
ISPWC 700

\* ROOT BARRIER

STANDARD ('S') FRAME  
AT CONCRETE PAVING

FINISH GRADE  
+ 1/4"

STL FRAME  
TYPE "P/A"  
ADJUST TO  
FINISH GRADE

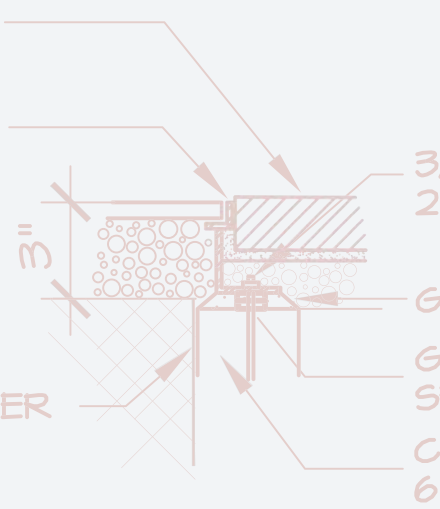

\* ROOT BARRIER

PAVER/ADJUSTABLE ('P/A')  
FRAME AT BRICK PAVING

STREET TREE  
RUNE UP TO  
CLEAR.

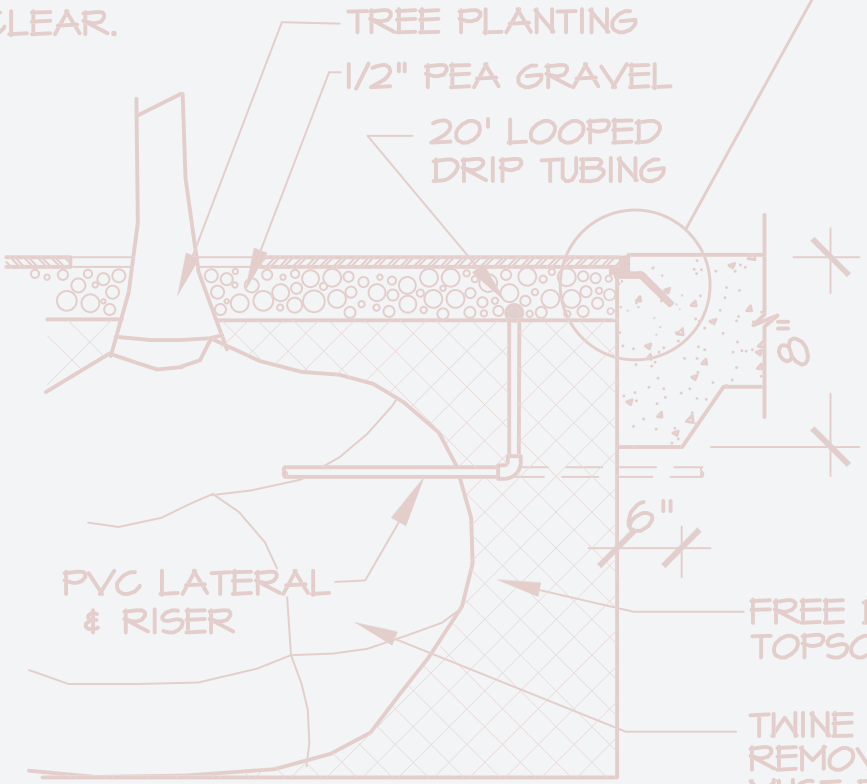

TREE PLANTING  
1/2" PEA GRAVEL  
20' LOOPED  
DRIP TUBING

PVC LATERAL  
& RISER

FREE DRAINING TREE WELL.  
TOPSOIL PLANTING MIX.

TWINE & BURLAP SHALL BE  
REMOVED. THE ROOT FLARE  
MUST BE EXPOSED & PLANTED  
AT GROUND LEVEL.

TYPE "R"  
RETRO  
FRAME



\* ROOT BARRIER

RETRO FIT ('R') FRAME  
AT EXISTING SIDEWALK

\* INSTALL BIOBARRIER ROOT BARRIER (OR APPROVED EQUAL) THAT EXTENDS 18" BELOW THE FINISH GRADE ON THE SIDEWALK SIDE AND 24" BELOW THE SUB GRADE ON THE CURB SIDE.

INSTALL CIP 4'x8' TREE GRATES AND FRAMES. TO BE "KIVA" BY URBAN ACCESSORIES.

This page intentionally left blank.



## LEGAL DISCLAIMER

The Streetscape Project shall be constructed in accordance with the overall City of Boise (“City”) infrastructure plans, policies, and design standards and with the applicable portions of the Downtown Boise Streetscape Standards. Upon adoption by the Capital City Development Corporation (CCDC) Board of Directors, this Downtown Boise Streetscape Standards & Specifications Manual will supersede previous versions of the Downtown Boise Streetscape Standards and Downtown Boise Elements of Continuity as follows:

- For streetscapes in the Central District, this manual will supersede Attachments No. 3F and 3G to the 2007 Amended and Restated Central District Urban Renewal Plan, adopted by the CCDC Board of Commissioners on March 15, 2007 by Resolution No. 1090 and by the Boise City Council on June 26, 2007 by Ordinance No. 6576; or as subsequently amended by CCDC Board of Commissioners.
- For streetscapes in the River Myrtle-Old Boise District, this manual will supersede Attachments No. 3B and 3C to the River Myrtle-Old Boise Urban Renewal Project Plan, adopted by the CCDC Board of Commissioners on August 23, 2004 by Resolution No. 1002 and by the Boise City Council on November 30, 2004 by Ordinance No. 6362; or as subsequently amended by CCDC Board of Commissioners.
- For streetscapes in the Westside Downtown District, this manual will supersede part of the Attachment No. 3 to the Westside Downtown Urban Renewal Project Plan (Westside Downtown Framework Master Plan - Section II: Design Standards), adopted by the CCDC Board of Commissioners on October 15, 2001 by Resolution No. 861 and by the Boise City Council on December 4, 2001 by Ordinance No. 6108; or as subsequently amended by CCDC Board of Commissioners.

Throughout this document, references are made to certain equipment, materials, or furnishings. Such items may be substituted by equivalent items as shall be approved in writing by Boise City, in consultation with CCDC as appropriate.